



**NONRESIDENT  
TRAINING  
COURSE**

**SEPTEMBER 1998**



---

# **Navy Electricity and Electronics Training Series**

## **Module 23—Magnetic Recording**

**NAVEDTRA 14195**

Although the words “he,” “him,” and “his” are used sparingly in this course to enhance communication, they are not intended to be gender driven or to affront or discriminate against anyone.

## PREFACE

By enrolling in this self-study course, you have demonstrated a desire to improve yourself and the Navy. Remember, however, this self-study course is only one part of the total Navy training program. Practical experience, schools, selected reading, and your desire to succeed are also necessary to successfully round out a fully meaningful training program.

**COURSE OVERVIEW:** To introduce the student to the subject of Magnetic Recording who needs such a background in accomplishing daily work and/or in preparing for further study.

**THE COURSE:** This self-study course is organized into subject matter areas, each containing learning objectives to help you determine what you should learn along with text and illustrations to help you understand the information. The subject matter reflects day-to-day requirements and experiences of personnel in the rating or skill area. It also reflects guidance provided by Enlisted Community Managers (ECMs) and other senior personnel, technical references, instructions, etc., and either the occupational or naval standards, which are listed in the *Manual of Navy Enlisted Manpower Personnel Classifications and Occupational Standards*, NAVPERS 18068.

**THE QUESTIONS:** The questions that appear in this course are designed to help you understand the material in the text.

**VALUE:** In completing this course, you will improve your military and professional knowledge. Importantly, it can also help you study for the Navy-wide advancement in rate examination. If you are studying and discover a reference in the text to another publication for further information, look it up.

*1998 Edition Prepared by  
CTMC(SS) Milton Charles Georgo*

Published by  
NAVAL EDUCATION AND TRAINING  
PROFESSIONAL DEVELOPMENT  
AND TECHNOLOGY CENTER

**NAVSUP Logistics Tracking Number  
0504-LP-026-8460**

## **Sailor's Creed**

“I am a United States Sailor.

I will support and defend the Constitution of the United States of America and I will obey the orders of those appointed over me.

I represent the fighting spirit of the Navy and those who have gone before me to defend freedom and democracy around the world.

I proudly serve my country's Navy combat team with honor, courage and commitment.

I am committed to excellence and the fair treatment of all.”

# TABLE OF CONTENTS

<b>CHAPTER</b>	<b>PAGE</b>
1. Introduction to Magnetic Recording.....	1-1
2. Magnetic Tape.....	2-1
3. Magnetic Tape Recorder Heads .....	3-1
4. Magnetic Tape Recorder Transports .....	4-1
5. Magnetic Tape Recorder Record and Reproduce Electronics.....	5-1
6. Magnetic Tape Recorder Specifications.....	6-1
7. Digital Magnetic Tape Recording .....	7-1
8. Magnetic Disk Recording.....	8-1
 <b>APPENDIX</b>	
I. Glossary.....	AI-1
II. References .....	AII-1
<b>INDEX</b> .....	INDEX-1

## CREDITS

The figures listed below and included in this edition of NEETS, Module 23, *Magnetic Recording*, were provided by Datatape, Inc. Permission to use these illustrations is gratefully acknowledged.

<u>SOURCE</u>	<u>FIGURE</u>
Datatape, Inc.	3-2, 3-3, 3-4, 5-3, 6-3, 6-4 A&B, 7-1, 7-4, 7-5, 7-6

# NAVY ELECTRICITY AND ELECTRONICS TRAINING SERIES

The Navy Electricity and Electronics Training Series (NEETS) was developed for use by personnel in many electrical- and electronic-related Navy ratings. Written by, and with the advice of, senior technicians in these ratings, this series provides beginners with fundamental electrical and electronic concepts through self-study. The presentation of this series is not oriented to any specific rating structure, but is divided into modules containing related information organized into traditional paths of instruction.

The series is designed to give small amounts of information that can be easily digested before advancing further into the more complex material. For a student just becoming acquainted with electricity or electronics, it is highly recommended that the modules be studied in their suggested sequence. While there is a listing of NEETS by module title, the following brief descriptions give a quick overview of how the individual modules flow together.

**Module 1, *Introduction to Matter, Energy, and Direct Current***, introduces the course with a short history of electricity and electronics and proceeds into the characteristics of matter, energy, and direct current (dc). It also describes some of the general safety precautions and first-aid procedures that should be common knowledge for a person working in the field of electricity. Related safety hints are located throughout the rest of the series, as well.

**Module 2, *Introduction to Alternating Current and Transformers***, is an introduction to alternating current (ac) and transformers, including basic ac theory and fundamentals of electromagnetism, inductance, capacitance, impedance, and transformers.

**Module 3, *Introduction to Circuit Protection, Control, and Measurement***, encompasses circuit breakers, fuses, and current limiters used in circuit protection, as well as the theory and use of meters as electrical measuring devices.

**Module 4, *Introduction to Electrical Conductors, Wiring Techniques, and Schematic Reading***, presents conductor usage, insulation used as wire covering, splicing, termination of wiring, soldering, and reading electrical wiring diagrams.

**Module 5, *Introduction to Generators and Motors***, is an introduction to generators and motors, and covers the uses of ac and dc generators and motors in the conversion of electrical and mechanical energies.

**Module 6, *Introduction to Electronic Emission, Tubes, and Power Supplies***, ties the first five modules together in an introduction to vacuum tubes and vacuum-tube power supplies.

**Module 7, *Introduction to Solid-State Devices and Power Supplies***, is similar to module 6, but it is in reference to solid-state devices.

**Module 8, *Introduction to Amplifiers***, covers amplifiers.

**Module 9, *Introduction to Wave-Generation and Wave-Shaping Circuits***, discusses wave generation and wave-shaping circuits.

**Module 10, *Introduction to Wave Propagation, Transmission Lines, and Antennas***, presents the characteristics of wave propagation, transmission lines, and antennas.

**Module 11**, *Microwave Principles*, explains microwave oscillators, amplifiers, and waveguides.

**Module 12**, *Modulation Principles*, discusses the principles of modulation.

**Module 13**, *Introduction to Number Systems and Logic Circuits*, presents the fundamental concepts of number systems, Boolean algebra, and logic circuits, all of which pertain to digital computers.

**Module 14**, *Introduction to Microelectronics*, covers microelectronics technology and miniature and microminiature circuit repair.

**Module 15**, *Principles of Synchros, Servos, and Gyros*, provides the basic principles, operations, functions, and applications of synchro, servo, and gyro mechanisms.

**Module 16**, *Introduction to Test Equipment*, is an introduction to some of the more commonly used test equipments and their applications.

**Module 17**, *Radio-Frequency Communications Principles*, presents the fundamentals of a radio-frequency communications system.

**Module 18**, *Radar Principles*, covers the fundamentals of a radar system.

**Module 19**, *The Technician's Handbook*, is a handy reference of commonly used general information, such as electrical and electronic formulas, color coding, and naval supply system data.

**Module 20**, *Master Glossary*, is the glossary of terms for the series.

**Module 21**, *Test Methods and Practices*, describes basic test methods and practices.

**Module 22**, *Introduction to Digital Computers*, is an introduction to digital computers.

**Module 23**, *Magnetic Recording*, is an introduction to the use and maintenance of magnetic recorders and the concepts of recording on magnetic tape and disks.

**Module 24**, *Introduction to Fiber Optics*, is an introduction to fiber optics.

Embedded questions are inserted throughout each module, except for modules 19 and 20, which are reference books. If you have any difficulty in answering any of the questions, restudy the applicable section.

Although an attempt has been made to use simple language, various technical words and phrases have necessarily been included. Specific terms are defined in Module 20, *Master Glossary*.

Considerable emphasis has been placed on illustrations to provide a maximum amount of information. In some instances, a knowledge of basic algebra may be required.

Assignments are provided for each module, with the exceptions of Module 19, *The Technician's Handbook*; and Module 20, *Master Glossary*. Course descriptions and ordering information are in NAVEDTRA 12061, *Catalog of Nonresident Training Courses*.



Throughout the text of this course and while using technical manuals associated with the equipment you will be working on, you will find the below notations at the end of some paragraphs. The notations are used to emphasize that safety hazards exist and care must be taken or observed.

### **WARNING**

AN OPERATING PROCEDURE, PRACTICE, OR CONDITION, ETC., WHICH MAY RESULT IN INJURY OR DEATH IF NOT CAREFULLY OBSERVED OR FOLLOWED.

### **CAUTION**

AN OPERATING PROCEDURE, PRACTICE, OR CONDITION, ETC., WHICH MAY RESULT IN DAMAGE TO EQUIPMENT IF NOT CAREFULLY OBSERVED OR FOLLOWED.

### **NOTE**

An operating procedure, practice, or condition, etc., which is essential to emphasize.

# INSTRUCTIONS FOR TAKING THE COURSE

## ASSIGNMENTS

The text pages that you are to study are listed at the beginning of each assignment. Study these pages carefully before attempting to answer the questions. Pay close attention to tables and illustrations and read the learning objectives. The learning objectives state what you should be able to do after studying the material. Answering the questions correctly helps you accomplish the objectives.

## SELECTING YOUR ANSWERS

Read each question carefully, then select the BEST answer. You may refer freely to the text. The answers must be the result of your own work and decisions. You are prohibited from referring to or copying the answers of others and from giving answers to anyone else taking the course.

## SUBMITTING YOUR ASSIGNMENTS

To have your assignments graded, you must be enrolled in the course with the Nonresident Training Course Administration Branch at the Naval Education and Training Professional Development and Technology Center (NETPDTC). Following enrollment, there are two ways of having your assignments graded: (1) use the Internet to submit your assignments as you complete them, or (2) send all the assignments at one time by mail to NETPDTC.

**Grading on the Internet:** Advantages to Internet grading are:

- you may submit your answers as soon as you complete an assignment, and
- you get your results faster; usually by the next working day (approximately 24 hours).

In addition to receiving grade results for each assignment, you will receive course completion confirmation once you have completed all the

assignments. To submit your assignment answers via the Internet, go to:

<https://courses.cnet.navy.mil>

**Grading by Mail:** When you submit answer sheets by mail, send all of your assignments at one time. Do NOT submit individual answer sheets for grading. Mail all of your assignments in an envelope, which you either provide yourself or obtain from your nearest Educational Services Officer (ESO). Submit answer sheets to:

COMMANDING OFFICER  
NETPDTC N331  
6490 SAUFLEY FIELD ROAD  
PENSACOLA FL 32559-5000

**Answer Sheets:** All courses include one “scannable” answer sheet for each assignment. These answer sheets are preprinted with your SSN, name, assignment number, and course number. Explanations for completing the answer sheets are on the answer sheet.

**Do not use answer sheet reproductions:** Use only the original answer sheets that we provide—reproductions will not work with our scanning equipment and cannot be processed.

Follow the instructions for marking your answers on the answer sheet. Be sure that blocks 1, 2, and 3 are filled in correctly. This information is necessary for your course to be properly processed and for you to receive credit for your work.

## COMPLETION TIME

Courses must be completed within 12 months from the date of enrollment. This includes time required to resubmit failed assignments.

## **PASS/FAIL ASSIGNMENT PROCEDURES**

If your overall course score is 3.2 or higher, you will pass the course and will not be required to resubmit assignments. Once your assignments have been graded you will receive course completion confirmation.

If you receive less than a 3.2 on any assignment and your overall course score is below 3.2, you will be given the opportunity to resubmit failed assignments. **You may resubmit failed assignments only once.** Internet students will receive notification when they have failed an assignment--they may then resubmit failed assignments on the web site. Internet students may view and print results for failed assignments from the web site. Students who submit by mail will receive a failing result letter and a new answer sheet for resubmission of each failed assignment.

## **COMPLETION CONFIRMATION**

After successfully completing this course, you will receive a letter of completion.

## **ERRATA**

Errata are used to correct minor errors or delete obsolete information in a course. Errata may also be used to provide instructions to the student. If a course has an errata, it will be included as the first page(s) after the front cover. Errata for all courses can be accessed and viewed/downloaded at:

<https://www.advancement.cnet.navy.mil>

## **STUDENT FEEDBACK QUESTIONS**

We value your suggestions, questions, and criticisms on our courses. If you would like to communicate with us regarding this course, we encourage you, if possible, to use e-mail. If you write or fax, please use a copy of the Student Comment form that follows this page.

## **For subject matter questions:**

E-mail: n315.products@cnet.navy.mil  
Phone: Comm: (850) 452-1001, ext. 1728  
DSN: 922-1001, ext. 1728  
FAX: (850) 452-1370  
(Do not fax answer sheets.)  
Address: COMMANDING OFFICER  
NETPDTC N315  
6490 SAUFLEY FIELD ROAD  
PENSACOLA FL 32509-5237

## **For enrollment, shipping, grading, or completion letter questions**

E-mail: fleetservices@cnet.navy.mil  
Phone: Toll Free: 877-264-8583  
Comm: (850) 452-1511/1181/1859  
DSN: 922-1511/1181/1859  
FAX: (850) 452-1370  
(Do not fax answer sheets.)  
Address: COMMANDING OFFICER  
NETPDTC N331  
6490 SAUFLEY FIELD ROAD  
PENSACOLA FL 32559-5000

## **NAVAL RESERVE RETIREMENT CREDIT**

If you are a member of the Naval Reserve, you will receive retirement points if you are authorized to receive them under current directives governing retirement of Naval Reserve personnel. For Naval Reserve retirement, this course is evaluated at 2 points. (Refer to *Administrative Procedures for Naval Reservists on Inactive Duty*, BUPERSINST 1001.39, for more information about retirement points.)

THIS PAGE LEFT BLANK INTENTIONALLY.

## Student Comments

**Course Title:** *NEETS Module 23*  
*Magnetic Recording* \_\_\_\_\_

**NAVEDTRA:** 14195 **Date:** \_\_\_\_\_

**We need some information about you:**

Rate/Rank and Name: \_\_\_\_\_ SSN: \_\_\_\_\_ Command/Unit \_\_\_\_\_

Street Address: \_\_\_\_\_ City: \_\_\_\_\_ State/FPO: \_\_\_\_\_ Zip \_\_\_\_\_

**Your comments, suggestions, etc.:**

<p><b>Privacy Act Statement:</b> Under authority of Title 5, USC 301, information regarding your military status is requested in processing your comments and in preparing a reply. This information will not be divulged without written authorization to anyone other than those within DOD for official use in determining performance.</p>
--

NETPDTC 1550/41 (Rev 4-00)



# CHAPTER 1

## INTRODUCTION TO MAGNETIC RECORDING

### LEARNING OBJECTIVES

Learning objectives are stated at the beginning of each chapter. They serve as a preview of the information you are expected to learn in the chapter. The comprehension check questions placed within the text are based on the objectives. By successfully completing those questions and the associated NRTC, you show that you have met the objectives and have learned the information. The learning objectives for this chapter are listed below.

After completing this chapter, you will be able to do the following:

1. Describe the history and purpose of magnetic recording.
2. State the prerequisites for magnetic recording.
3. Describe a magnetic recording head, how it's constructed, and how it operates.

### INTRODUCTION

Have you ever wondered how a whole album of your favorite music got onto one of those little cassette tapes? Or, what about computer floppy disks; have you ever wondered how they can hold 180 or more pages of typed text? The answer to both of these questions is *magnetic recording*.

Magnetic recording devices seldom get much attention until they fail to work. But without magnetic recording, recording your favorite television show on a video cassette recorder would be impossible, portable tape players wouldn't exist, and you wouldn't be able to get money from an automated bank teller machine at two o'clock in the morning.

Now what about the Navy? Could it operate without magnetic recording? The answer is definitely no. Without it:

- Computer programs and data would have to be stored on either paper cards or on rolls of paper tape. Both of these methods need a lot of storage space, and they take much longer to load into and out of the computer.
- There wouldn't be any movies to show or music to play on the ship's entertainment system when the ship is at sea and is out of range for television and radio reception.
- Intelligence-collection missions would be impossible since you couldn't store the collected signals for later analysis.

As you can see, magnetic recording plays a very important part both in our Navy life and in our civilian life.

## HISTORY OF MAGNETIC RECORDERS

In 1888, Oberlin Smith originated the idea of using permanent magnetic impressions to record sounds. Then in 1900, Vladeniar Poulsen brought Mr. Smith's dream to reality. At the Paris Exposition, he demonstrated a Telegraphone. It was a device that recorded sounds onto a steel wire. Although everyone thought it was a great idea, they didn't think it would succeed since you had to use an earphone to hear what was recorded. It wasn't until 1925, when electronic amplifiers were developed, that magnetic recording started to receive the attention it deserved.

The best magnetic recording is the one that produces an output signal identical to the input signal. It didn't take long to realize that the magnetism generated during the recording process didn't vary directly to the current which caused it. This is because there's a *step* in the magnetism curve where it crosses the zero point and changes polarity. This step causes the output signal to be distorted when compared with the input signal. Figure 1-1 shows this step.

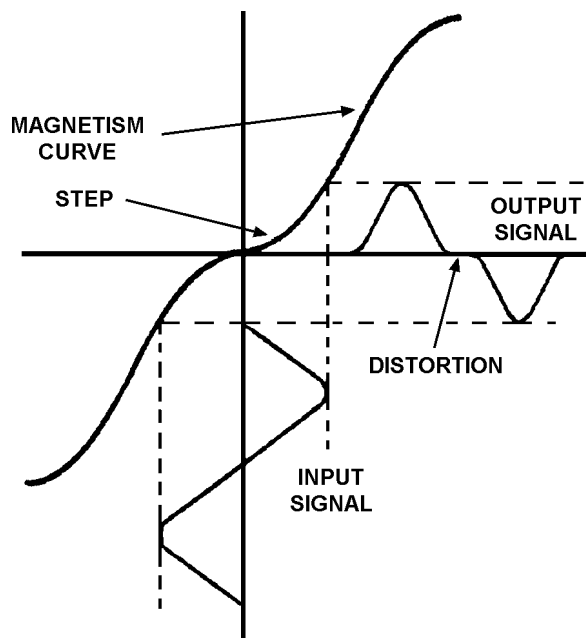

Figure 1-1.—Magnetic recording without bias voltage.

In 1907, Mr. Poulsen discovered a solution to this problem. He discovered *dc* bias. He found that if a fixed dc voltage were added to the input signal, it moved the input signal away from the *step* in the magnetism curve. This prevented the input signal from crossing the zero-point of the magnetism curve. The result is an output signal exactly like the input signal. Figure 1-2 shows this process.



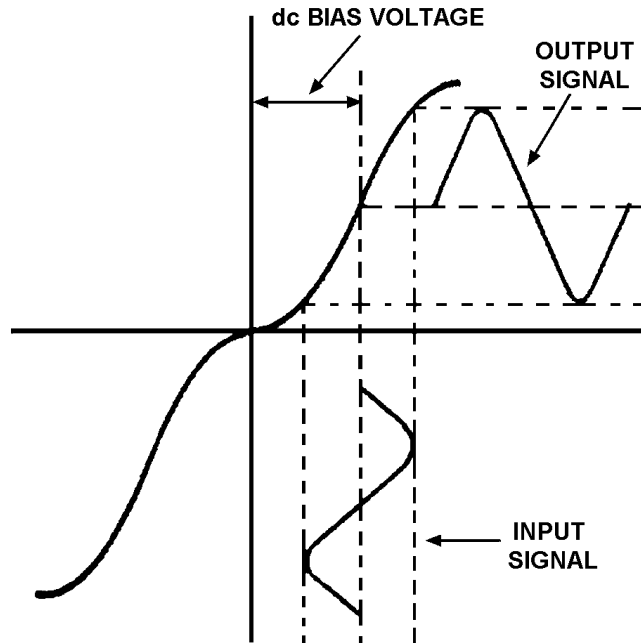

Figure 1-2.—Magnetic recording with dc bias voltage.

Unfortunately, dc bias had its problems. Since only a small portion of the magnetism curve was straight enough to use, the output signal was weak compared with the natural hiss of the unmagnetized tape passing the playback head. This is commonly called poor signal-to-noise ratio (SNR). We'll explain SNR in more detail later.

From the beginning, the U.S. Naval Research Laboratories (NRL) saw great potential in magnetic recording. They were especially interested in using it to transmit telegraph signals at high speed. After electronic amplifiers were invented around 1925, W.L. Carlson and G.W. Carpenter at the NRL made the next important magnetic recording discovery. They found that adding an ac bias voltage to the input signal instead of a fixed dc bias voltage would

- reproduce a stronger output signal
- greatly improve the signal-to-noise ratio
- greatly reduce the natural tape hiss that was so common with dc bias

To make ac bias work, they used an ac frequency for the bias voltage that was well above what could be heard, and a level that placed the original input signal away from both *steps* in the magnetism curve. This resulted in two undistorted output signals that could be combined into one strong output. See figure 1-3.

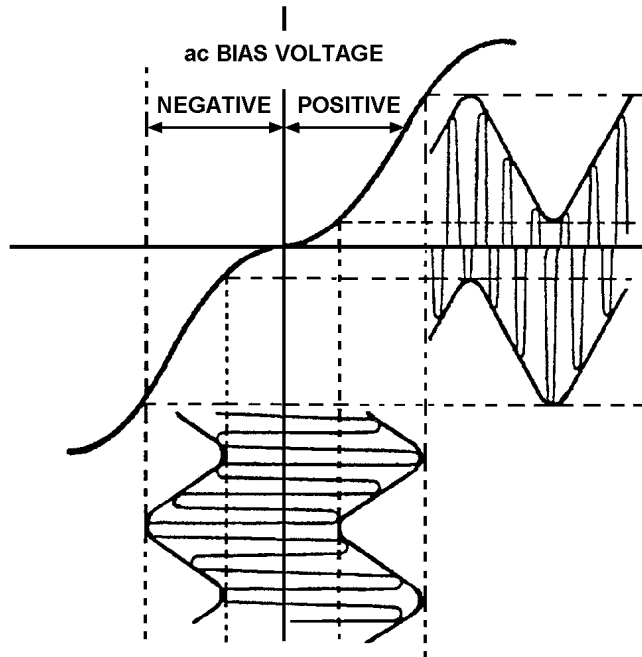

Figure 1-3.—Magnetic recording with ac bias voltage.

Until 1935, all magnetic recording was on steel wire. Then, at the 1935 German Annual Radio Exposition in Berlin, Fritz Pfleumer demonstrated his Magnetophone. It used a cellulose acetate tape coated with soft iron powder. The Magnetophone and its "paper" tapes were used until 1947 when the 3M Company introduced the first plastic-based magnetic tape.

In 1956, IBM introduced the next major contribution to magnetic recording—the hard disk drive. The disk was a 24-inch solid metal platter and stored 4.4 megabytes of information. Later, in 1963, IBM reduced the platter size and introduced a 14-inch hard disk drive.

Until 1966, all hard disk drives were "fixed" drives. Their platters couldn't be removed. Then in 1966, IBM introduced the first removable-pack hard disk drive. It also used a 14-inch solid metal platter.

In 1971, magnetic tape became popular again when the 3M Company introduced the first 1/4-inch magnetic tape cartridge and tape drive. In that same year, IBM invented the 8-inch floppy disk and disk drive. It used a flexible 8-inch platter of the same material as magnetic tape. Its main goal was to replace punched cards as a program-loading device.

The next contribution to magnetic recording literally started the personal computer (PC) revolution. In 1980, a little-known company named Seagate Technology invented the 5-1/4-inch floppy disk drive. Without it, PCs as we know them today would not exist.

From then on, it was all downhill. Magnetic tape became more sophisticated. Floppy disks and disk drives became smaller, while their capacities grew bigger. And hard disk capacities just went through the roof. All of the major hurdles affecting magnetic recording had been successfully cleared, and it was just a matter of refining both its methods and materials.

*Q-1. Why did the early inventors of magnetic recording find it necessary to add a fixed dc bias to the input signal?*

*Q-2. How does dc bias added to the input signal correct the distortion in the output signal?*

Q-3. Why does adding dc vice ac bias voltage to the input signal result in a poor signal-to-noise ratio (SNR)?

Q-4. What are three advantages of adding an ac bias voltage to the input signal instead of adding a fixed dc bias voltage?

Q-5. Why does using ac vice dc bias voltage result in a stronger output signal?

## PREREQUISITES FOR MAGNETIC RECORDING

To perform magnetic recording, you need three things:

1. An input signal you wish to record.
2. A recording medium. (This is a recording surface that will hold the signal you wish to record.)
3. A magnetic head to convert the input signal into a magnetic field so it can be recorded.

If any one of these are missing, magnetic recording cannot take place.

### Input Signal

An input signal can come from a microphone, a radio receiver, or any other source that's capable of producing a recordable signal. Some input signals can be recorded immediately, but some must be *processed* first. This processing is needed when an input signal is weak, or is out of the frequency response range of the recorder.

### Recording Medium

A recording medium is any material that has the ability to become magnetized, in varying amounts, in small sections along its entire length. Some examples of this are magnetic tape and magnetic disks. These are thoroughly discussed in chapter 2 of this module.

### Magnetic Heads

Magnetic heads are the heart of the magnetic recording process. They are the transducers that convert the electrical variations of your input signal into the magnetic variations that are stored on a recording medium. Without them, magnetic recording isn't possible.

Magnetic heads actually do three different things. They transfer, or *record*, the signal information onto the recording medium. They recover, or *reproduce*, the signal information from the recording medium. And they remove, or erase, the signal information from the recording medium.

**MAGNETIC HEAD CONSTRUCTION.**—A magnetic head is a magnetic core wrapped with a coil of very thin wire (see figure 1-4). The core material is usually shaped like the letter C, and is made from either iron or ceramic-ferrite material. The number of turns of wire placed on the core depends on the purpose of that specific head. The gap in the core is called a *head gap*. It's here that magnetic recording actually takes place. We'll go into more detail of magnetic head construction in chapter 3.

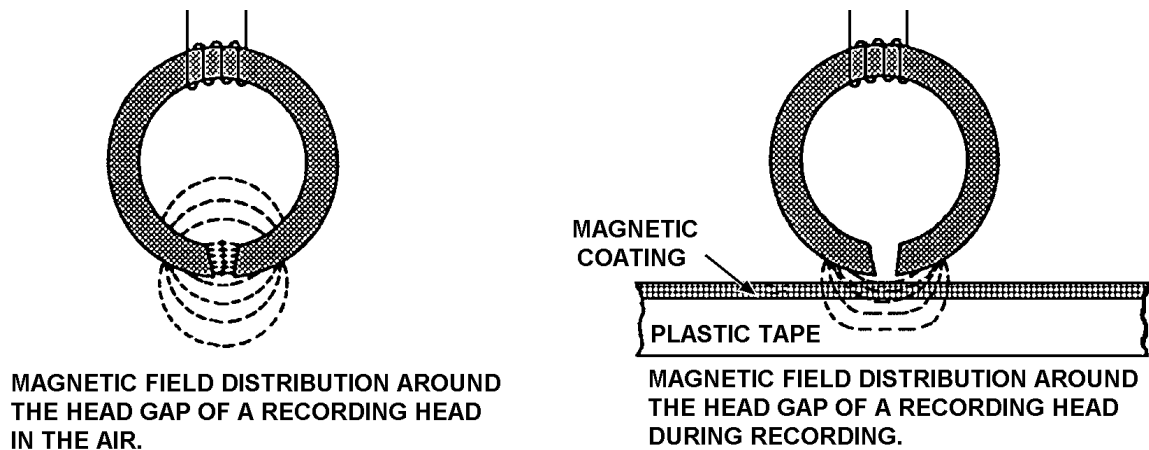

Figure 1-4.—Magnetic field distribution around the head gap.

**MAGNETIC HEAD OPERATION.**—Whether you're recording on magnetic tapes or disks, all magnetic heads operate the same way. When an electric current passes through the coil of a magnetic head, magnetic field lines associated with the electric current follow paths through the core material. When the magnetic fields get to the head gap, some of them spread outside the core to form a *fringing field*. When a recording medium is passed through this fringing field, it is magnetized in relation to the electric current. This is called magnetic recording. Figure 1-4 illustrates this process.

Q-6. What three things are required to perform magnetic recording?

Q-7. What is the meaning of the term recording medium as it pertains to magnetic recording?

Q-8. What are the three functions of the magnetic heads on a magnetic recording device?

## SUMMARY

This chapter briefly covered the historical development of magnetic recording principles and devices. The following is a summary of important points in the chapter.

The **BEST MAGNETIC RECORDING** is one that produces an output signal that is identical to the input signal. However, a *step* in the magnetic curve causes the output signal to be distorted.

In 1907, **DC BIAS** was added to the input signal to remove the distortion in the output signal. But the dc bias caused a weak output signal with a poor SNR. Around 1925, the NRL used **AC BIAS** to reproduce a stronger output signal and greatly improve the SNR.

To perform magnetic recording, you need (1) an **INPUT SIGNAL**, (2) a **RECORDING MEDIUM**, and (3) a **MAGNETIC HEAD**.

A **RECORDING MEDIUM** is any material that can become magnetized in varying amounts (such as magnetic tape and disks).

**MAGNETIC HEADS** are used to (1) *record* the signal onto the recording medium, (2) *reproduce* the signal from the recording medium, and (3) *erase* the signal from the recording medium.

## ANSWERS TO QUESTIONS Q1. THROUGH Q8.

A-1. *Because a step in the magnetism curve where it crosses the zero point and changes polarity causes the output signal to be distorted. See figure 1-1.*

A-2. *The dc bias moves the input signal away from the step in the magnetism curve. This prevents the input signal from crossing the zero-point of the magnetism curve. See figure 1-2.*

A-3. *With dc bias, the SNR is poor because only a small portion of the magnetism curve is straight enough to use, thus the output signal is weak compared with the natural tape hiss.*

A-4.

a. *Reproduces a stronger output signal.*

b. *Greatly improves the SNR.*

c. *Greatly reduces the natural tape hiss.*

A-5. *Because an ac bias voltage of the proper frequency and level places the input signal away from both steps in the magnetism curve. The result is two undistorted output signals that are combined into one strong output.*

A-6.

a. *An input signal.*

b. *A recording medium.*

c. *A magnetic head.*

A-7. *A recording medium is any material that has the ability to become magnetized, in varying amounts, in small sections along its entire length.*

A-8.

a. *Record the signal onto the recording medium.*

b. *Reproduce the signal from the recording medium.*

c. *Erase the signal from the recording medium.*



## CHAPTER 2

# MAGNETIC TAPE

### LEARNING OBJECTIVES

After completing this chapter, you'll be able to do the following:

1. Describe the physical properties of magnetic tape in terms of:
  - a. The Three Basic Materials Used To Make Magnetic Tape.
2. The function of the magnetic tape's *base material*, *oxide coating*, and *binder glue*.
3. Describe the two types of magnetic recording tape.
4. Describe the following types of tape errors and their effects on magnetic tape recording: *signal dropout*, *noise*, *skew*, and *level*.
5. Describe the following causes of magnetic tape failure: *normal wear*, *accidental damage*, *environmental damage*, and *winding errors*.
6. Describe the purpose and makeup of tape reels and tape cartridges.
7. Describe the two methods for erasing magnetic tape, the characteristics of automatic and manual tape degaussers, and the procedures for degaussing magnetic tape.
8. Describe the proper procedures for handling, storing, and packaging magnetic tape, tape reels, and tape cartridges.

### PHYSICAL PROPERTIES OF MAGNETIC TAPE

The three basic materials used to make magnetic tape are (1) the base material, (2) the coating of magnetic oxide particles, and (3) the glue to bind the oxide particles onto the base material. See figure 2-1.

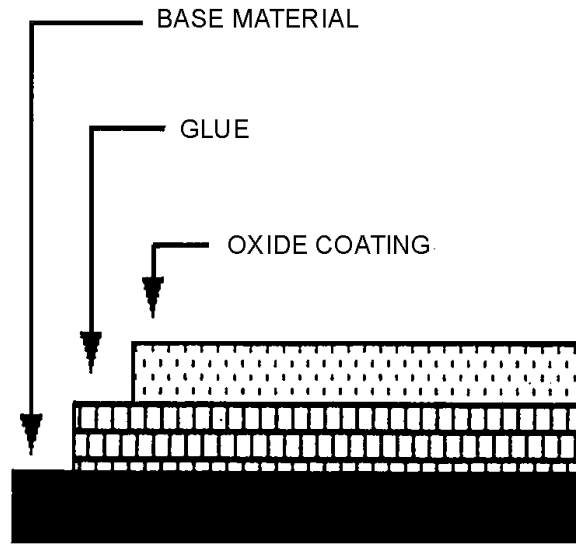

Figure 2-1.—Magnetic tape construction.

## BASE MATERIAL

The base material for magnetic tape is made of either plastic or metal. Plastic tape is used more than metal tape because it's very flexible, it resists mildew and fungus, and it's very stable at high temperatures and humidity.

## OXIDE COATING

Oxide particles that can be magnetized are coated onto the base material. The most common magnetic particles used are either gamma ferric oxide or chromium dioxide. It's very important that these magnetic particles are uniform in size. If they're not, the tape's surface will be abrasive and will reduce the life of the recorder's magnetic heads.

An ideal magnetic particle is needle-shaped. It's actual size depends on the frequency of the signal to be recorded. Generally, long particles are used to record long wavelength signals (low-frequency signals), and short particles are used to record short wavelength signals (high-frequency signals).

## GLUE

The glue used to bond the oxide particles to the base material is usually an organic resin. It must be strong enough to hold the oxide particles to the base material, yet be flexible enough not to peel or crack.

## TYPES OF MAGNETIC RECORDING TAPE

There are two basic types of magnetic recording tape in common use: *analog* and *digital*. Analog magnetic tape is used to record, store, and reproduce audio and instrumentation type signals. These signals are usually in a frequency band from very-low frequency (VLF) to 2.5 MHz. Digital magnetic tape is used to record, store, and reproduce computer programs and data. It's base material thickness is about 50 percent thicker than analog magnetic tape. This allows the digital tape to withstand the more strenuous starts and stops associated with digital magnetic recorder search, read, and write functions.



Digital magnetic tape is also held to much stricter quality control standards. It's important not to have any blemishes or coating flaws on the tape's surface. Because, if you lost one digital data bit, your computer program or data would be bad. In contrast, losing one microsecond of an analog signal is not nearly as critical.

*Q-1. Magnetic tape is made of what three basic materials?*

*Q-2. Why is plastic magnetic tape used more than metal tape?*

*Q-3. Which of the two types of magnetic tape is used to record audio and instrumentation type signals in the VLF to 2.5MHz frequency range?*

*Q-4. What type of magnetic tape is used to record computer programs and data, and what are the additional thickness and quality standards for this type of tape?*

## **TAPE ERRORS AND THEIR EFFECTS**

Four types of tape errors that will degrade the performance of a magnetic recording system are signal dropout, noise, skew, and level (signal amplitude changes).

### **DROPOUT ERRORS**

Signal dropout is the most common and the most serious type of tape error. It's a temporary, sharp drop (50% or more) in signal strength caused by either contaminates on the magnetic tape or by missing oxide coating on part of the tape.

During recording and playback, the oxide particles on the tape can flake off and stick to the recorder's guides, rollers, and heads. After collecting for awhile, the oxide deposits (now oxide lumps) break loose and stick to the magnetic tape. As the tape with the lumps passes over the head, the lumps get between the tape and the head and lift the tape away from the head. This causes the signal dropouts. Although oxide lumps cause most signal dropouts, remember that any contaminate (such as dust, lint or oil) that gets between the tape and the head can cause signal dropouts.

### **NOISE ERRORS**

Noise errors are unwanted signals that appear when no signal should appear. They're usually caused by a cut or a scratch on the magnetic tape. It's the lack of oxide particles at the cut or the scratch that causes the noise error.

### **SKEW ERRORS**

Skew errors only occur on multi-track magnetic tape recorders. The term skew describes the time differences that occur between individual tracks of a single magnetic head when the multi-track tape isn't properly aligned with the magnetic head.

There are two types of skew errors: *fixed* and *dynamic*. Fixed skew happens when properly aligned magnetic tape passes an improperly aligned magnetic head. Dynamic skew happens when misaligned tape passes a properly aligned head. This type of skew is usually caused by one or more of the following:

- A misaligned or worn-out tape transport system.
- A stretched or warped magnetic tape.

- A magnetic tape that is improperly wound on a reel.

## LEVEL ERRORS

Magnetic tape is manufactured to have a specified output signal level (plus or minus some degree of error). Level errors happen when the actual output signal level either drops or rises to a level outside the expected range. For example, if a magnetic tape is rated for 10 volts ( $\pm 10\%$ ), any output signal level below 9 volts or above 11 volts is a level error. Level errors are caused by an uneven oxide coating on the magnetic tape. This can come from either the original manufacturing process or from normal wear and tear.

Some causes of level errors are permanent and cannot be removed by any means. For example, a crease in the tape, a hole in the oxide, or a damaged edge. Other causes of level errors are removable and may be cleaned off the tape. For example, oxide flakes or clumps, metallic particles, or dirt are removable.

*Q-5. What are four types of tape errors that can degrade a magnetic recording system's performance?*

*Q-6. What are signal dropouts, and what are two tape defects that can cause signal dropouts?*

*Q-7. What is the most common and most serious type of signal dropout?*

*Q-8. You see a build-up of dust and lint on the take-up reel of a tape recorder. This can cause which of the four types of tape errors?*

*Q-9. What type of tape error causes noise to appear on the tape when no signal should appear? What causes this type of tape error?*

*Q-10. The multi-track tape recorder in your computer system has a fixed skew error. What does this mean and what is the probable cause?*

*Q-11. Some tapes you are using may have level errors. What does this mean and what is the cause?*

## CAUSES OF MAGNETIC TAPE FAILURE

Tape failure happens when a magnetic tape's performance degrades to a point where it's no longer usable. The *exact* point where failure occurs will vary, depending on the type of tape and how it is used.

There are four main causes for tape failure:

1. Normal wear (natural causes)
2. Accidental damage
3. Environmental damage
4. Winding errors

## NORMAL WEAR

Normal wear occurs because the tape must come in contact with fixed surfaces, such as a recorder's magnetic heads, rollers, and guides. Over time, this repeated contact with the fixed surfaces causes excessive dropout errors and makes the tape unusable.

## **ACCIDENTAL DAMAGE**

Accidental tape damage that causes tape failure is any damage that wouldn't normally occur under ideal operating and handling conditions. It can be caused by either a human operator or the tape recorder itself. Accidental tape damage caused by human operators can range from accidentally dropping a reel of magnetic tape to improperly threading a magnetic tape recorder. Accidental tape damage caused by recording equipment can occur if the recorder is poorly designed or if the tape transport mechanism is adjusted improperly.

## **ENVIRONMENTAL DAMAGE**

The negative effect of environmental extremes on tape can also cause tape failure. Magnetic tape is very flexible and can be used in a wide range of environmental conditions. It's designed for use in a temperature range of about 2 to 130 degrees Fahrenheit (-20 to 55 degrees Celsius), and in a relative humidity range of about 10 to 95%. Of course, these numbers are the *extreme*. Ideally, magnetic tape should be used and stored at a temperature of about 60 to 80° F (room temperature), and in a relative humidity of about 40 to 60%.

Large changes from the ideal relative humidity cause tape to expand or contract and thus affect the uniformity of a tape's oxide coating. High relative humidity causes the tape to stretch and increases the tape's friction. The increased friction causes increased head wear, head clog by oxide particles, and head-to-tape sticking. Low relative humidity encourages oxide shedding and increases static build-up on tape surfaces, causing the tape to collect airborne contaminants.

The effects of exceeding the ideal temperature and humidity ranges described above can cause the following environmental damage to magnetic tape: *tape deformation, oxide shedding, head-to-tape sticking, layer-to-layer sticking, dirt build-up, and excessive tape and head wear.*

### **Tape Deformation**

Magnetic tapes are wound onto tape reels with tension applied. This tension causes great layer-to-layer pressure within the reel pack. Changes in temperature and humidity can cause the backing material to expand or contract, creating even more pressure. All of this pressure causes the tape to become deformed or warped.

### **Oxide Shedding**

At temperatures above 130° F, a tape's oxide coating tends to become soft. At temperatures below 2° F, the oxide coating tends to be brittle. In both cases, the oxide coating will shed, flake off, or otherwise become separated from the base material. These free pieces of oxide will then stick to parts of the tape transport, to the magnetic heads, or back onto the tape and cause dropout or level errors.

### **Head-to-Tape Sticking**

At higher temperatures, the tape binder glue can soften to the point where it will stick to the recorder's magnetic head. This head-to-tape sticking causes jerky tape motion.

### **Layer-to-Layer Adhesion**

When reels of magnetic tape are stored at higher temperatures, the tape's binder glue may melt and cause the layers of tape to stick to one another. In very severe cases, layer-to-layer adhesion can separate the oxide coating from the base material and completely destroy a tape.

## **Dirt Build-up**

Dirt build-up happens when the relative humidity level is less than 10%. The low humidity causes static electricity that attracts dirt and dust which builds up on the magnetic tape and other parts of the magnetic tape recorder.

## **Excessive Tape and Head Wear**

When the relative humidity is more than 95%, the high humidity causes increased friction as the tape passes over the heads. This, in turn, causes excessive tape and head wear.

*Q-12. What is tape failure?*

*Q-13. What are four main causes of tape failure?*

*Q-14. How does normal wear cause tape failure?*

*Q-15. Accidental damage to magnetic tape is normally caused by the tape recorder itself or by human operators of the recorder. What are three frequent causes of such accidental damage?*

*Q-16. Environmental damage to magnetic tape can occur when the tape is stored in an area that exceeds what ideal temperature and humidity ranges?*

*Q-17. What six types of environmental damage can occur to tapes in storage when the ideal temperature and humidity ranges are exceeded?*

*Q-18. After using a tape that was stored in an area where temperatures exceeded 130° F you notice pieces of oxide sticking to the recorder's tape-transport mechanism, to its magnetic heads, and onto the tape. What is the probable cause of these symptoms?*

*Q-19. Your activity stores its magnetic tape in an area where the temperature is 100° F. What two types of environmental damage could occur that would make these tapes unusable?*

*Q-20. When the relative humidity is below 10%, what happens to magnetic tape and parts of a tape recorder that could cause environmental damage?*

*Q-21. How does relative humidity over 95% cause excessive tape and head wear?*

## **WINDING ERRORS**

Winding errors are another cause of tape failure. They happen when improper winding practices create an excessive or uneven force as the tape is being wound onto a tape reel. The form taken by the tape after it is wound onto the reel is called the *tape pack*. Winding errors can cause a deformed tape pack that will prevent good head-to-tape contact.

In most cases, a deformed tape pack can be fixed simply by rewinding it onto another reel at the proper tension and at the right temperature and humidity. The four most common types of tape pack deformation are:

1. Cinching
2. Pack-slip
3. Spoking

#### 4. Windowing

##### **Cinching**

Cinching happens when a tape reel is stopped too quickly. The sudden stop causes the outer layers of magnetic tape to continue to spin after the inner layers have stopped. This causes any loosely wound tape within the pack to unwind and pile up. Figure 2-2 shows an example of a cinched tape pack (note the complete foldover of one tape strand).

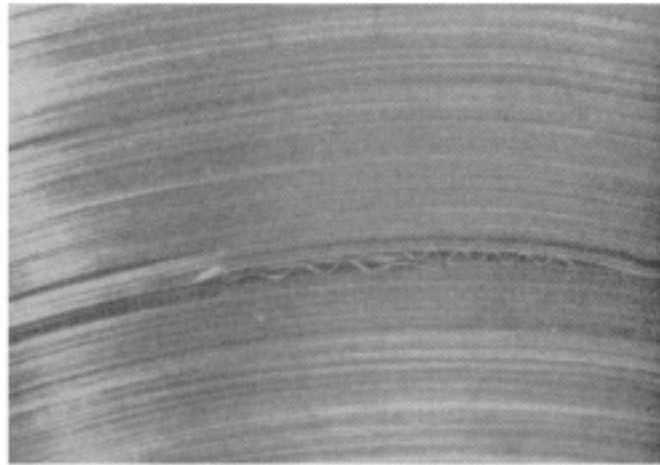

**Figure 2-2.—Example of cinched tape pack.**

##### **Pack Slip**

Pack slip happens when the tape is loosely wound on the reel and is exposed to excessive vibration or too much heat. This causes the tape to shift (side-to-side), causing *steps* in the tape pack. When a tape reel with pack slip is used, the magnetic tape will unwind unevenly and rub against the sides of the tape reel or the recorder's tape guides. This can damage the magnetic tape and cause oxide shedding. Figure 2-3 shows an example of pack slip.

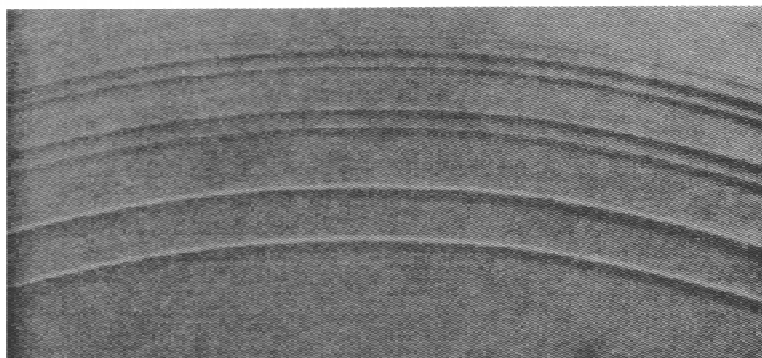

**Figure 2-3.—Example of pack slip.**

## Spoking

Spoking happens when magnetic tape is wound onto the tape reel with the tension increasing toward the end of the winding. The higher tension on the outside of the tape pack causes the inner pack to buckle and deform. Spoking is also caused by the uneven pressures created when a tape is wound on a reel that has a distorted hub, or when the tape is wound over a small particle that is deposited on the hub. Figure 2-4 shows a spoked tape pack.

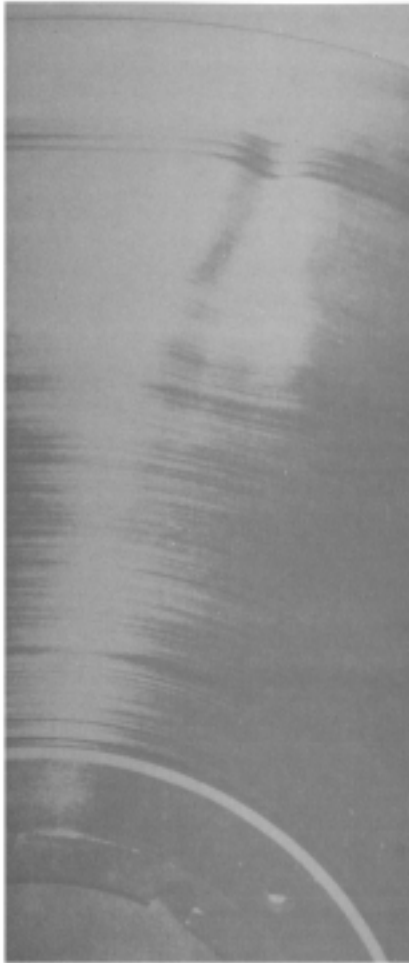

Figure 2-4.—Example of spoked tape pack.

## Windowing

Windows are voids or see-through air gaps in the tape winding. They happen when magnetic tape is loosely wound onto a tape reel, and especially when the loosely wound reel is later exposed to extreme heat or humidity. Figure 2-5 shows a windowed tape pack.

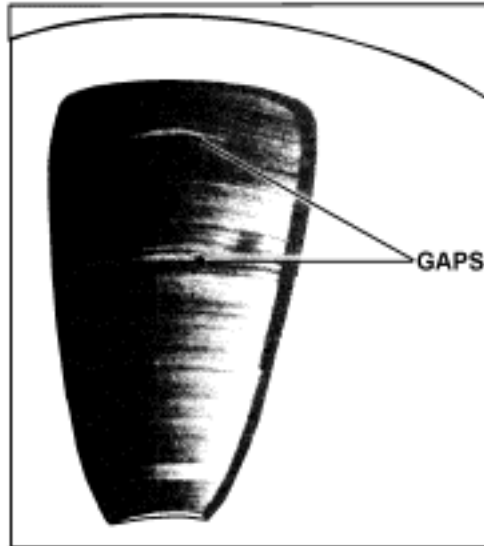

Figure 2-5.—Example of windowed tape pack.

- Q-22. *Tape winding errors can cause a deformed tape pack. What are four common types of tape pack deformation?*
- Q-23. *After rewinding a tape onto its supply reel, you examine the tape pack and notice pile-ups of tape resembling the example in figure 2-2. What causes this condition?*
- Q-24. *You notice steps in the tape pack such as those in figure 2-3. What causes this and how does it damage the magnetic tape?*
- Q-25. *A tape pack is buckled and deformed as shown in figure 2-4. What are three possible causes for this condition?*
- Q-26. *A tape pack has gaps in the tape winding as shown in figure 2-5. What causes this condition?*

## TAPE REELS AND TAPE CARTRIDGES

There are two types of magnetic tape carriers: *tape reels* and *tape cartridges*. Both types can be used for either analog or digital recording. Tape cartridges are normally used only for digital recording.

### TAPE REELS

Tape reels are used on magnetic recorders that use a manually loaded tape supply reel and a separate take-up reel. A reel's purpose is to protect the magnetic tape from damage and contamination. It can be made of plastic, metal, or glass. A reel has two parts, the hub and the flanges.

A tape reel is designed to hold magnetic tape on its hub without letting the magnetic tape touch the sides of the flanges. Contrary to popular belief, the flanges are not designed to *guide* the magnetic tape onto the tape reel.

## TAPE CARTRIDGES

Tape cartridges hold a spool of magnetic tape in the same way as tape reels, except that the inside of the cartridge contains both the supply reel and the take-up reel. Unlike tape reels which must be manually loaded into a recorder, when you insert a tape cartridge into a recorder, it's automatically loaded and ready to use. Figure 2-6 shows two typical tape cartridges.



Figure 2-6.—Typical tape cartridges.

*Q-27. When winding a tape onto a plastic or metal reel, should the tape ever touch the reel's flanges?*

## TAPE ERASING AND DEGAUSSING

One advantage of magnetic tape is that you can erase what you've previously recorded, and record on the same tape again and again. The erasing is done by demagnetizing the magnetic tape. You demagnetize a magnetic tape by exposing it to a gradually decreasing ac (alternating current) magnetic field. There are two ways to do this: (1) with an *erase head* that's mounted on the magnetic recorder, or (2) with a separate *tape degausser*.

### ERASE HEADS

A magnetic recorder's erase head erases magnetic tape by saturating it with an ac signal that's higher in frequency than the frequency range of the recorder itself. This method of erasing a tape works well in some cases, but it's not the best way because:

- It's slow; the tape must be run through the recorder to be erased.



- If the erase head is not completely demagnetized, it may not do a complete erasure.
- Some recorders do not have erase heads installed.

## MAGNETIC TAPE DEGAUSSERS

By far, the best way to erase a magnetic tape is to use a separate magnetic tape degausser. There are two types of degaussers: *automatic* and *manual*.

### Automatic Tape Degausser

Automatic degaussers erase magnetic tape by automatically moving the whole tape reel or cartridge slowly and steadily in and out of an intense ac magnetic field. This type of degausser erases a tape very well. Some automatic degaussers are made specifically for tape reels, and some are made for both tape reels and tape cartridges. Figure 2-7 shows a typical automatic degausser.

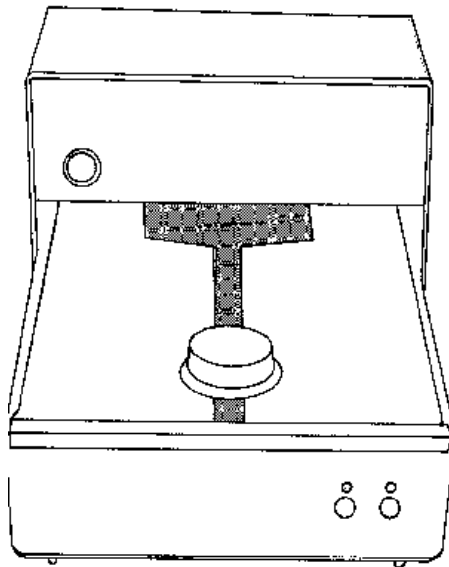

Figure 2-7.—Automatic tape degausser.

### Manual Tape Degausser

Both manual and automatic tape degaussers use the same electronic principles for erasing magnetic tape. However, the manual version is much more portable. It's small, hand-held, and much less expensive. Figure 2-8 shows a typical manual degausser.



**Figure 2-8.—Manual tape degausser.**

To erase tapes with a manual degausser:

1. Place the tape reel or cartridge to be erased on a flat surface.
2. Hold the degausser very close to the magnetic tape and turn it on.
3. Slowly rotate the degausser in circles around the tape reel or cartridge for a few seconds.
4. Then slowly move it away until you're about 12 to 14 inches away from the tape reel or tape cartridge.
5. Turn off the degausser.

*Q-28. What are two disadvantages of using a recorder's erase head to erase data recorded on a magnetic tape?*

*Q-29. What method for erasing magnetic tape is much more effective and reliable than using a recorder's erase head?*

### **HANDLING, STORING, AND PACKAGING MAGNETIC TAPE**

Today's magnetic tape coatings can store recorded signals for years. The data recorded is a permanent record that won't fade or weaken with age. And, it'll remain unchanged until it's altered by another magnetic field or until the tape coating deteriorates.

When magnetic tape recordings are ruined, the cause is usually poor handling, improper storage, or shipping damage. If you want your tape recordings to last a long time, you need to know how to properly handle, store, and ship magnetic tape.

## **HANDLING MAGNETIC TAPE**

A magnetic tape reel or cartridge should always be in one of two places, either mounted on a tape recorder or in its storage container. When you handle magnetic tape, follow these rules:

- DO use extreme care when handling magnetic tape. Careless handling can damage magnetic tape, tape reels, and tape cartridges. Always hold a tape reel by the hub, NEVER by the flanges, and NEVER handle or touch the working tape surface.
- DO NOT let the magnetic tape trail on the floor. Even though the end of the tape may not have data stored on it, it can pick up dirt and dust that ends up on the recorder.
- DO clean your hands before handling magnetic tape. You can contaminate magnetic tape with dirt and oils from dirty hands.
- DO mount tape reels and cartridges properly. Improperly seated tape reels can cause unnecessary wear and tear on the magnetic tape.
- DO replace any warped take-up reels, as they can damage magnetic tape.
- DO keep the magnetic recorder and its take-up reel clean. Magnetic tape can pick up dirt and dust from the recorder itself.
- DO NOT use the top of a magnetic recorder as a work area. This can expose the magnetic tape to dirt, excessive heat, and stray magnetic fields.
- DO NOT allow eating, drinking, or smoking in areas where magnetic tape or devices are exposed.

## **STORING MAGNETIC TAPE**

Most magnetic tape reels and cartridges spend a lot of time in storage. It's very important that you protect the stored tape from physical damage and the damaging effects of contamination and temperature and humidity extremes. If you don't, damage to the tape pack such as oxide shedding, layer-to-layer sticking, and tape deformation can happen. To protect magnetic tape from damage during storage, follow these rules:

- DO make sure that magnetic tape is wound properly on the reel hub and at the proper tension.
- DO always store tape reels vertically. DO NOT lay them on their side.
- DO maintain a proper environment. Keep the storage area clean, and at a 60 to 80F degree temperature and a 40 to 60% relative humidity.
- DO NOT store magnetic tapes near any equipment that generates stray magnetic fields.
- DO handle all tape reels and cartridges as gently as possible.
- DO NOT eat, drink, or smoke in a magnetic tape storage area.

## PACKAGING MAGNETIC TAPE FOR SHIPPING

There may be times when you are asked to package magnetic tape reels or tape cartridges for shipment. If you want the tape to arrive in good condition, you must pack it properly to protect it from damage. The packaging you use must protect the tape reels or cartridges from impact, vibration, and temperature and humidity changes. Here are some simple rules to follow:

- DO always package tape reels so that they're supported by their hub. This prevents any pressure on the reel's flanges that might flex the flanges against the tape pack. Figure 2-9 shows a shipping box that supports the tape reel by the hub.

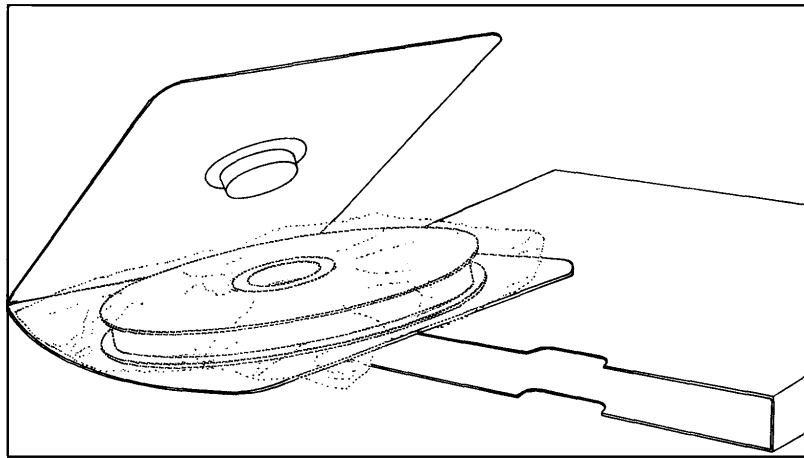

Figure 2-9.—Reel box that supports reel by the hub.

- DO always use reel bands where available. Reel bands are for placement around the outside edges of the reel flanges to help prevent the flanges from flexing and damaging the tape.
  - DO always ship magnetic reels in a container designed so its normal positioning is with the reels in a vertical position. This will prevent the tape pack from shifting and damaging the edges of the magnetic tape.
  - DO always package tape cartridges in their shipping cases. Tape cartridges are more durable than tape reels, but they still need to be protected during shipment.
- Q-30. *When magnetic tapes are ruined, what three factors are normally the cause?*
- Q-31. *What is the correct way to hold a magnetic tape reel?*
- Q-32. *The take-up reel on your recorder is warped. What should you do to/with the reel?*
- Q-33. *If magnetic tape is stored in areas with temperature and humidity extremes, what are three types of tape damage that may occur?*
- Q-34. *List four rules you should follow when storing magnetic tape to protect it from damage.*
- Q-35. *When packaging tape reels or cartridges for shipping, what are four rules you should follow to protect the tape reels from impact and vibration?*

## SUMMARY

Now that you've finished chapter 2, you should be able to (1) describe the physical properties of magnetic tape, (2) recognize the four most common magnetic tape errors, (3) recognize the four causes of tape failure, (4) describe the two methods for erasing magnetic tape, and (5) use the proper procedures for handling, storing, and packaging magnetic tape, tape reels, and tape cartridges. The following is a summary of the important points in this chapter.

The three **BASIC MATERIALS** used to make magnetic tape are the (1) base material, (2) the oxide particles, and (3) the binder glue.

**ANALOG** and **DIGITAL** are the two basic types of magnetic tape in common use.

**BLEMISHES OR COATING FLAWS ON DIGITAL TAPE** can easily ruin the data or the computer program stored on the tape.

**SIGNAL DROPOUT, NOISE, SKEW, AND LEVEL** are four types of tape errors. Dropout errors are the most common.

**OXIDE LUMPS** accumulated on the tape cause most dropout errors. Other causes are dust or lint on the tape, or missing oxide coating on part of the tape.

**MAGNETIC TAPE FAILURE** has four main causes: (1) normal wear, (2) accidental damage, (3) environmental damage, and (4) winding errors.

**IDEAL TEMPERATURE AND HUMIDITY RANGES** for using and storing magnetic tape are 60 to 80° F and 40 to 60% relative humidity.

**ENVIRONMENTAL TAPE DAMAGE** caused by excessive temperature or humidity includes the following: (1) tape deformation, (2) oxide shedding, (3) head-to-tape sticking, (4) layer-to-layer sticking, (5) dirt buildup, and (6) excessive tape and head wear.

**WINDING ERRORS** can cause tape pack deformation. The four most common types are: (1) cinching, (2) pack slip, (3) spoking, and (4) windowing.

The **TWO PARTS OF A TAPE REEL** are the hub and the flanges. The tape should be wound on the hub. No part of the tape should be touching the flange sides.

**ERASE HEADS AND TAPE DEGAUSSERS** are two methods for erasing tape. Degaussers are the fastest and the most reliable.

Rules for **HANDLING MAGNETIC TAPE** are (1) always hold the reel by the hub, not the flanges, (2) never touch the working tape surface, (3) replace warped or damaged reels, and (4) mount reels and cartridges properly.

Rules for **STORING MAGNETIC TAPE** are (1) wind tape properly on the reel hub, (2) store tapes vertically, (3) keep storage area clean and at proper temperature and humidity levels, and (4) store tapes away from equipment that generates stray magnetic fields.

Rules for **PACKAGING TAPE FOR SHIPPING** are (1) support reels by their hubs, (2) use reel bands, (3) pack reels in containers vertically, and (4) keep tape cartridges in their shipping cases.

## ANSWERS TO QUESTIONS Q1. THROUGH Q35.

A-1.

- a. *Base material.*
- b. *Coating of magnetic oxide particles.*
- c. *Glue that bonds the particles to the base.*

A-2. *Plastic tape is used more than metal because it's more flexible, resists mildew and fungus, and is very stable at high temperatures and humidity.*

A-3. *Analog magnetic tape.*

A-4. *Digital magnetic tape is for computer programs and data. Its base material is about 50% thicker. The tape's surface must not have blemishes or coating flaws because losing even one digital data bit could ruin the recorded computer program or data.*

A-5. *Signal dropout, noise, skew, and level. Dropout is the most common.*

A-6. *Dropouts are temporary, sharp drops (50% or more) in signal strength. They're caused by contaminants that lift the tape away from the magnetic head, or when magnetic oxide coating is missing on part of the tape.*

A-7. *Oxide particles that get onto the magnetic tape.*

A-8. *Signal dropout errors and level errors. The dust and lint on the reel will eventually get onto the tape where it can get between the tape and the recorder's heads.*

A-9. *Noise error is usually caused by a cut or a scratch on the magnetic tape.*

A-10. *Skew means there are time differences between the individual tracks of a multi-track recorder's magnetic head. It happens when the tape isn't properly aligned with the head. Fixed skew happens when the tape passes over an improperly aligned magnetic head.*

A-11. *The actual output signal level of the tape exceeds the manufacturer's specified range for the output signal level (+ / - 10%). It's caused by an uneven oxide coating on the tape due to worn tape or defective manufacture.*

A-12. *Tape's performance degrades to a point where it's no longer usable.*

A-13. *Normal wear, accidental damage, environmental damage, and winding errors.*

A-14. *Repeated contact with a recorder's fixed surfaces such as magnetic heads, tape rollers, and tape guides.*

A-15.

- a. *Improperly adjusted tape transport mechanism.*
- b. *Dropping a reel of tape.*
- c. *Improperly threading tape.*

- A-16. *Ideally, use and store tape at 60 to 80° F and at 40 to 60% relative humidity.*
- A-17. *Tape deformation, oxide shedding, head-to-tape sticking, layer-to-layer sticking, dirt build-up, and excessive tape and head wear.*
- A-18. *Oxide shedding. At temperatures above 130° F, oxide coating becomes soft and sheds.*
- A-19. *Head-to-tape sticking and layer-to-layer adhesion.*
- A-20. *Dirt build-up caused by static electricity.*
- A-21. *High humidity causes increased friction as the tape passes over the heads.*
- A-22. *Cinching, pack slip, spoking, and windowing.*
- A-23. *The tape is stopped too quickly when winding or rewinding.*
- A-24. *Pack slip. It's caused by loosely wound tape on a reel that is exposed to excessive vibration or heat. The vibration or heat causes the tape to shift, causing steps in the tape pack. The uneven tape will then rub against the reel's sides and the recorder's tape guides.*
- A-25.
- a. *Reel has a distorted hub,*
  - b. *tape wound over small particle deposited on hub, and*
  - c. *tape wound on reel with tension increasing toward end of winding.*
- A-26. *Tape is loosely wound on reel.*
- A-27. *No. The reel is designed to hold the tape on its hub without letting the tape touch the sides of the flanges.*
- A-28. *Using an erase head is slow, and it may not completely erase the tape.*
- A-29. *Using a magnetic tape degausser.*
- A-30. *Poor handling, improper storage, or shipping damage.*
- A-31. *Always hold reel by the hub, never by the flanges. Never touch the working tape surface.*
- A-32. *Always replace a warped reel.*
- A-33. *Oxide shedding, layer-to-layer sticking, and tape deformation.*
- A-34.
- a. *Make sure the tape is wound properly on the reel hub,*
  - b. *store tapes vertically,*
  - c. *keep storage area at right temperature and humidity,*
  - d. *store away from equipment that generates stray magnetic fields.*

A-35.

- a. *Package reels so they're supported by their hub,*
- b. *use reel bands,*
- c. *package reels in vertical position,*
- d. *package tape cartridges in their shipping cases.*



## CHAPTER 3

# MAGNETIC TAPE RECORDER HEADS

### LEARNING OBJECTIVES

After completing this chapter, you'll be able to do the following:

1. Describe the construction, function, and placement of magnetic tape recorder record, reproduce, and erase heads.
2. Describe the preventive maintenance requirements for magnetic tape recorder heads.

### MAGNETIC TAPE RECORDER HEADS

Magnetic tape recorder heads are the *heart* of magnetic tape recording, because it's the magnetic heads (as we'll call them in this chapter) that actually:

1. Record signal or data information onto magnetic tape
2. Reproduce (play back) signal or data information from magnetic tape
3. Erase any signal or data off of magnetic tape

To do these things, a magnetic tape recorder can have up to three different heads installed: one head for recording, one for reproducing, and one for erasing. Some magnetic tape recorders will use the same head for both recording and reproducing. Figure 3-1 shows a typical multitrack magnetic head.

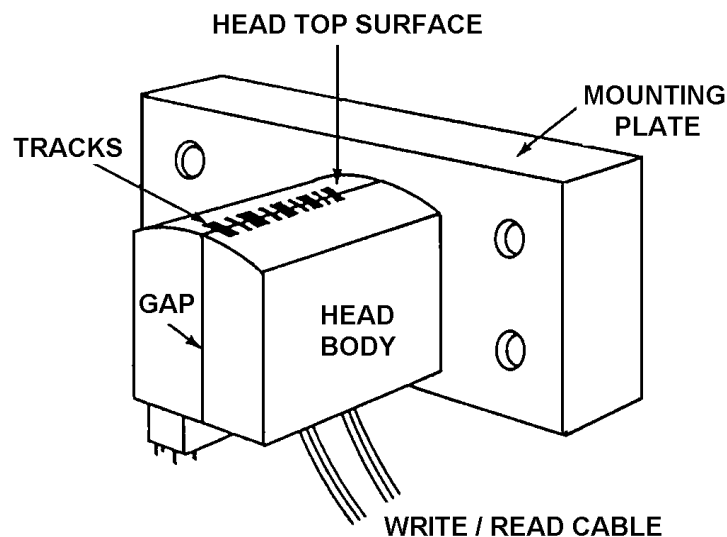

Figure 3-1.—Typical multitrack magnetic tape recorder head.

## MAGNETIC HEAD CONSTRUCTION

Magnetic head construction is *basically* the same for all magnetic heads. They're all made up of a magnetic core wrapped with a coil of very thin wire. But, there's where the similarity ends. From here on, each magnetic head is built to perform a specific job. Will the head be used on a single track recorder? Will it be used on a multitrack recorder? Will it be a record head or a reproduce head? Or, will it be an erase head? What frequency will it be recording and/or reproducing? The answers to these questions will determine the final construction of a magnetic head.

Figure 3-2 shows the construction of a typical multitrack magnetic head. Magnetic cores are wound with very thin wire, cemented together, and placed inside a half-bracket. A tip piece is then placed on top of the ferrite core, and the two half-brackets are assembled together. It's during this final assembly process that the headgap and the resulting frequency response of the magnetic head are determined. After some final contouring to give the magnetic head its curved face, it's ready for use.

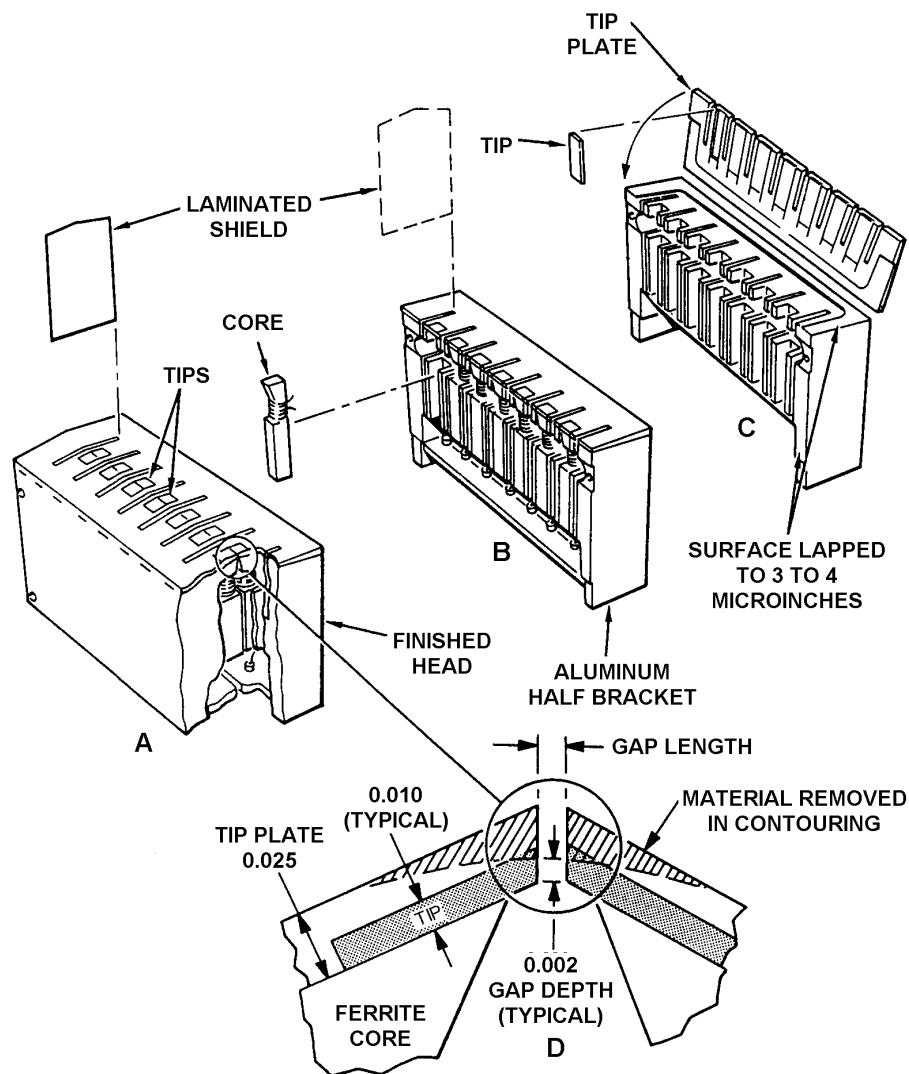

Figure 3-2.—Multitrack tape recorder head construction.

## Record and Reproduce Heads

Record and reproduce heads convert and transfer electrical signals onto and off of magnetic tape. The maximum frequency these heads can transfer depends on the size of the headgap and the speed of the magnetic tape (we'll discuss speed in the next chapter). Most record and reproduce heads are in one of these three general bandwidth categories:

1. Narrowband—100 Hz to 100 kHz
2. Intermediate band—100 Hz to 500 kHz
3. Wideband—400 Hz to 2 MHz

The only physical difference between a record head and a reproduce head is in the number of turns of wire on the core. A reproduce head will have more turns than a record head. This is because reproduce heads must be able to recover low-level signals from magnetic tape. The extra turns of wire allow the reproduce head to output the highest level possible and at a good signal-to-noise level.

Record heads are always placed before reproduce heads on magnetic tape recorders. This allows you to monitor signals that you're recording. Figure 3-3 shows the placement of record and reproduce heads. Figure 3-4 shows some of the typical track arrangements used.

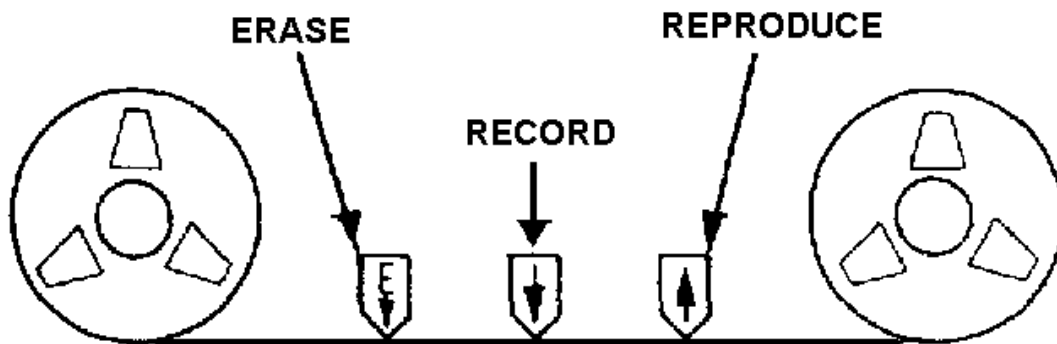

*Courtesy of DATATAPE Incorporated, Copyright © All rights reserved*

**Figure 3-3.—Placement of magnetic tape recorder heads.**

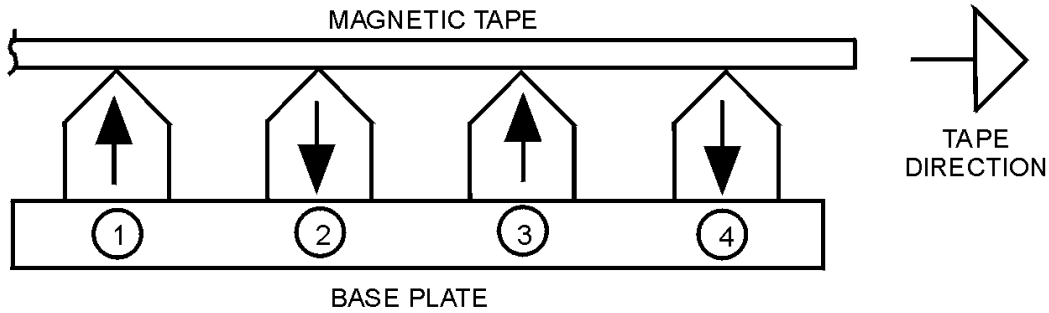

- 1 - ODD RECORD STACK
- 2 - ODD REPRODUCE STACK
- 3 - EVEN RECORD STACK
- 4 - EVEN REPRODUCE STACK

TRACK NUMBERING			
HEAD STACK	14 TRACK	28 TRACK	42 TRACK
1	1-13 RECORD	1-27 RECORD	1-41 RECORD
2	1-13 REPRODUCE	1-27 REPRODUCE	1-41 REPRODUCE
3	2-14 RECORD	2-28 RECORD	2-42 RECORD
4	2-14 REPRODUCE	2-28 REPRODUCE	2-42 REPRODUCE

*Courtesy of DATATAPE Incorporated, Copyright © All rights reserved*

Figure 3-4.—Magnetic head track placement.

### Erase Heads

Erase heads transfer a signal to the magnetic tape that causes the magnetic particles to assume a *neutralized* or *erased* state. To do this, a high current signal that is 3 to 5 times higher in frequency than the maximum frequency response of the record and reproduce heads is used. In some audio recorders, a simple direct current (dc) voltage is used.

Erase heads are always placed before the record and the reproduce heads on tape recorders. This allows you to erase the magnetic tape before it's recorded on. Figure 3-3 shows the placement of erase heads.

- Q-1. *Magnetic tape recorders can have up to three different heads installed. What are the three functions performed by a recorder's heads?*
- Q-2. *The way a magnetic head will be used determines how it is constructed. Name three factors that determine the final construction of a magnetic head.*
- Q-3. *What two specifications determine the maximum frequency that a recorder's record and reproduce heads will be able to transfer?*
- Q-4. *Most record and reproduce heads are in one of what three bandwidth categories?*
- Q-5. *Why are record heads always placed before reproduce heads on recorders?*
- Q-6. *A recorder's erase head is always placed in what sequence on the record/reproduce track?*

## **MAGNETIC HEAD MAINTENANCE**

It's very important to *regularly* maintain magnetic heads. If you do, you'll greatly reduce the chance of getting a poor recording or playback. Regular preventive maintenance will also increase the life of the magnetic heads. There are two things you must do to properly maintain magnetic heads: (1) keep them clean, and (2) keep them demagnetized.

### **Cleaning Magnetic Heads**

Through use, magnetic heads pick up dirt, dust, lint, and oxide particles from the magnetic tape. These particles collect on the magnetic head and, if left unchecked, could cause signal dropout errors that degrade the quality of recording and playback. To keep magnetic heads clean, regularly clean them with a cotton-tipped applicator soaked in either isopropyl alcohol or in a magnetic head cleaner recommended by the recorder's manufacturer. A good rule of thumb is to clean the heads each time you change a tape reel or cartridge.

### **Demagnetizing Magnetic Heads**

Magnetic heads can become magnetized from many sources. It could happen

- during ac power losses,
- during testing or alignment,
- because of stray magnetic fields,
- from normal use.

No matter the cause, magnetized magnetic heads degrade the quality of the magnetic recording or playback.

To demagnetize magnetic heads, you'll use a hand-held degausser. It could be like the one shown in figure 3-5, or like the manual degausser shown in the previous chapter. No matter how they look, they all generate an ac magnetic field that demagnetizes the metal parts of a magnetic head.

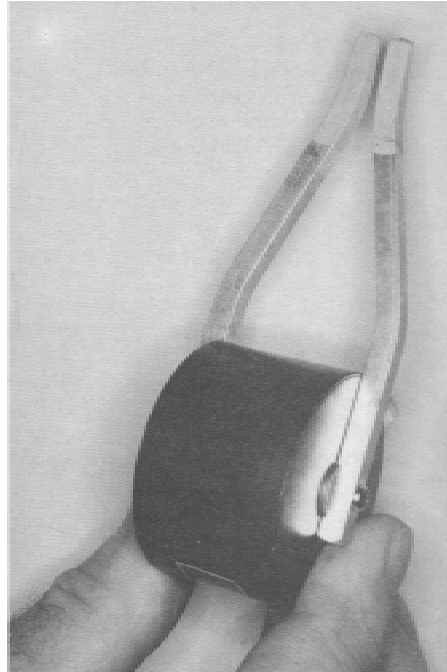

**Figure 3-5.—Hand-held head degausser.**

The procedure for demagnetizing a magnetic head is similar to the procedure for degaussing a magnetic tape. Here are the basic steps:

1. Remove the tape (reel or cartridge) from the magnetic recorder.
2. Holding the degausser an arm's length away from the magnetic head, energize the degausser.
3. *Slowly* bring the degausser closer and closer to the magnetic head. **Don't touch the head with the degausser.**
4. Move the degausser back and forth across the head for 15 to 30 seconds. Figure 3-6 shows how this looks.
5. *Slowly* move the degausser away from the magnetic head. When the degausser is an arm's length away, de-energize it.

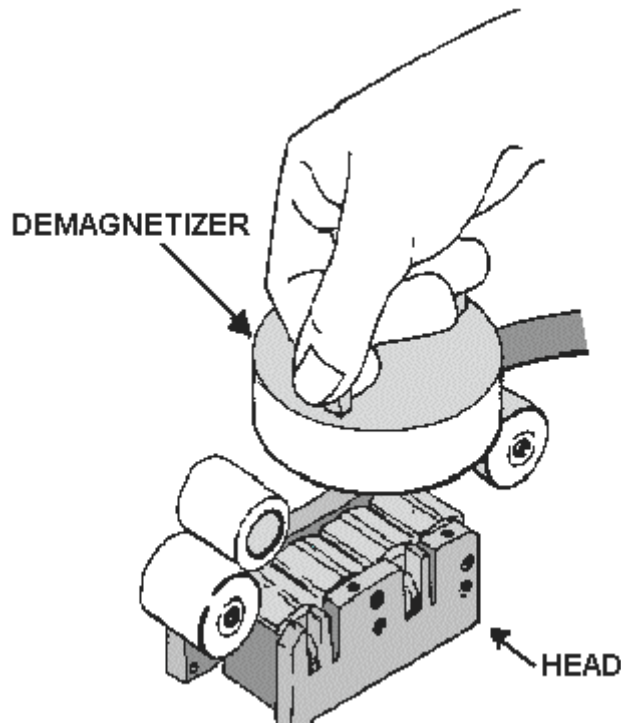

Figure 3-6.—Demagnetizing magnetic heads with a degausser.

That's all there is to it. It's hard to determine *exactly* how often magnetic heads should be de-magnetized. Manufacturer's recommendations vary from every 8 to 25 hours of operation. To be safe, check the equipment's technical manual.

*Q-7. What two preventive maintenance actions must you do regularly to increase magnetic head life and to ensure good tape recording and playback?*

*Q-8. How should you clean your recorder's magnetic heads?*

*Q-9. What are four sources that can cause magnetic heads to become magnetized?*

*Q-10. What type of equipment should you use to demagnetize your recorder's magnetic heads?*

*Q-11. How often should you demagnetize a recorder's magnetic heads?*

### SUMMARY

Now that you've finished chapter 3, you should be able to (1) describe the construction of magnetic tape recorder heads; (2) describe the purpose and placement of record, reproduce, and erase heads; and (3) describe the preventive maintenance requirements for tape recorder heads. The following is a summary of important points in this chapter:

Magnetic tape recorders have up to **THREE MAGNETIC HEADS** to perform the erase, record, or reproduce function.

Three factors that determine the **CONSTRUCTION OF A MAGNETIC HEAD** are the (1) type of head, (2) frequencies it will record, reproduce, or erase, and (3) use on a single or multitrack recorder.

Most tape recorder heads are designed for **ONE OF THREE BANDWIDTHS**: (1) narrowband, (2) intermediate band, or (3) wideband.

A recorder's magnetic heads are in the following **SEQUENCE** on its record/reproduce track: (1) erase, (2) record, and (3) reproduce.

Two important **PREVENTIVE MAINTENANCE** requirements for magnetic heads are cleaning and demagnetizing.

#### **ANSWER TO QUESTIONS Q1. THROUGH Q11.**

*A-1. Record, reproduce, and erase.*

*A-2.*

- a. Type of head (record, reproduce, or erase).*
- b. Frequencies it will record or reproduce.*
- c. Whether it will be used on a single or multitrack recorder.*

*A-3.*

- a. Size of the headgap.*
- b. Speed of the magnetic tape.*

*A-4.*

- a. Narrowband—100 Hz to 100 kHz.*
- b. Intermediate band—100 Hz to 500 kHz.*
- c. Wideband—400 Hz to 2 MHz.*

*A-5. Allow you to monitor the signals you're recording.*

*A-6. First, before the record and reproduce heads.*

*A-7.*

- a. Keep the heads clean.*
- b. Keep the heads demagnetized.*

*A-8. With a cotton-tipped applicator soaked in either isopropyl alcohol or a head cleaner recommended by the recorder's manufacturer.*



*A-9.*

- a. During ac power losses.*
- b. During testing.*
- c. Because of stray magnetic fields.*
- d. From normal use.*

*A-10. A hand-held degausser like the manual degaussers used for degaussing magnetic tape.*

*A-11. Every 8 to 25 hours depending on the manufacturer's recommendations.*



# CHAPTER 4

## MAGNETIC TAPE RECORDER TRANSPORTS

### LEARNING OBJECTIVES

After completing this chapter, you'll be able to do the following:

1. Describe the function and components of a basic magnetic tape transport system.
2. Describe the operating characteristics and parts of the three most common tape reeling systems.
3. Describe the physical characteristics of the two basic tape reeling configurations, *co-planar* and *co-axial*.
4. Describe the characteristics of *open-loop drive* and *closed-loop drive* tape transport configurations and the three most common *closed-loop* designs.
5. Describe the capstan speed control function of a tape transport system and the relationship of the six basic parts of a typical capstan speed control unit.
6. Explain why, and describe how, magnetic tape transports must be cleaned and degaussed.

### INTRODUCTION

Magnetic tape recorder transports are precisely built assemblies that move the magnetic tape across the magnetic heads and hold and protect the tape. Figure 4-1 shows a basic tape transport assembly. Tape transports have four basic parts:

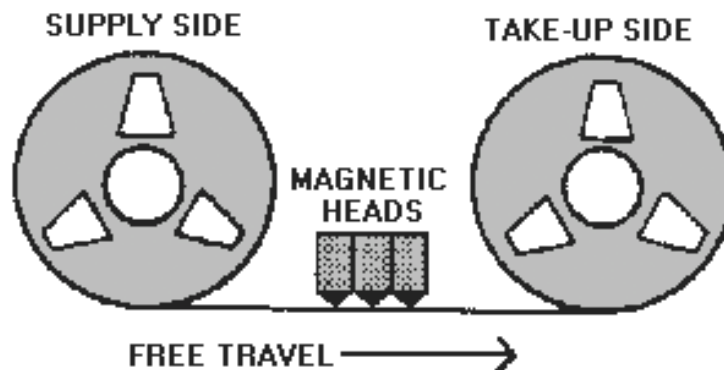

Figure 4-1.—Basic tape transport assembly.

1. A **tape reeling system** that, with the aid of tape guides, physically moves the tape across the magnetic heads.
2. A **tape speed control system** that monitors and controls the movement of the magnetic tape.
3. An **electronic subsystem** that activates the reeling device to move the magnetic tape.
4. A **basic enclosure** that holds and protects the reels or cartridges of magnetic tape.

This chapter describes these basic parts, tells how they work, and shows diagrams of the more common ones.

## TAPE REELING SYSTEMS

A basic magnetic recorder tape reeling system (figure 4-1) has one supply reel and one take-up reel. Its job is to move the magnetic tape from one reel to the other. When this happens, four things occur:

1. The supply reel feeds out magnetic tape at a constant tension.
2. The tape passes the magnetic heads in a straight line.
3. The take-up reel accepts the magnetic tape at a constant tension.
4. Both the supply and take-up reels start and stop smoothly while maintaining the proper tape tension.

These four things must happen, or the magnetic tape could be damaged. Three of the most commonly used tape reeling systems are (1) take-up control, (2) two-motor reeling, and (3) tape buffering.

### TAKE-UP CONTROL REELING SYSTEMS

This system uses a motorized take-up reel which pulls the magnetic tape off of a *free-spooling* supply reel. It maintains tape tension by using mechanical drag on the supply reel. As you might guess, this method has its disadvantages. It only works in one direction, and the tape tension doesn't remain constant throughout the reel. As the supply reel gives out tape, the tape tension varies. Uneven tape tension can cause stretched tape, poorly wound tape reels, and tape damage during starts and stops.

### TWO-MOTOR REELING SYSTEMS

To overcome the problems of take-up control reeling systems, designers added a motor to the supply reel. By using two motors, the magnetic tape direction can be forward or reverse.

Two-motor reeling configurations usually use dc (direct current) motors, instead of ac (alternating current) motors, because dc motors run smoother and are easier to control. To help control tape tension, a small hold-back voltage is added to the motor for the supply reel.

Unfortunately, two-motor reeling systems do not properly control tape tension during starts and stops. Something called *tape buffering* must be added.

## TAPE BUFFERING REELING SYSTEMS

Controlling a recorder's tape tension during starts and stops is a big problem. Tape buffering overcomes this problem by regulating the tape reel speed and by protecting against changes in tape tension.

Every manufacturer of high-quality, high performance magnetic tape recorders uses some sort of tape buffering. It's especially important in magnetic recorders that operate at many different speeds, where precise tape tension must be maintained.

Figure 4-2 shows the relationship between the tape reeling system and the tape buffering system. As you can see, the speed at which a tape reel will give up or take up magnetic tape is controlled by its respective speed control servo. Feedback from the supply and take-up buffers tells the servo to speed up or slow down.

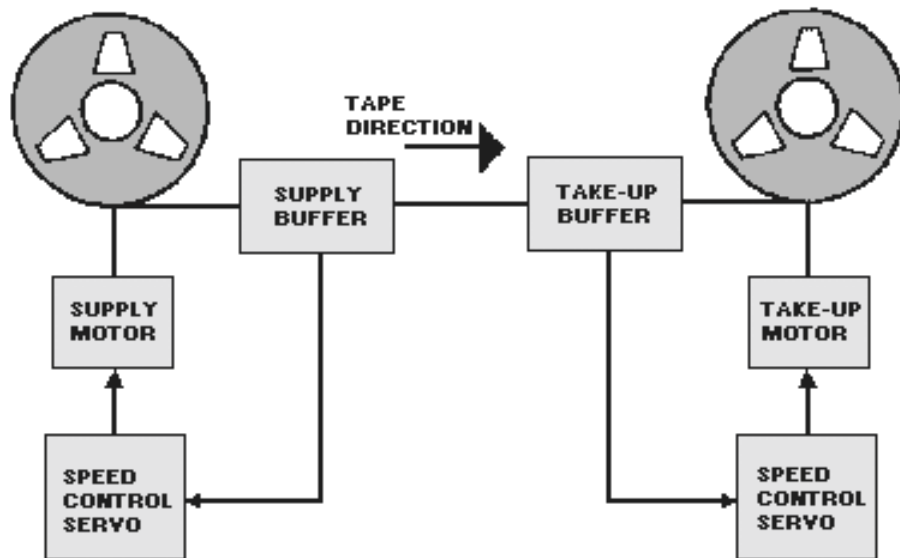

Figure 4-2.—Tape buffering arrangement.

There are two basic types of reeling system buffers: (1) spring-tension, and (2) vacuum-column.

1. **Spring-tension** buffering systems use an electro-mechanical device to sense changes in tape tension. These changes are *feedback* that the speed control servo needs to adjust the speed of the tape reels. Figures 4-3 and 4-4 show two of the more common arrangements for spring-tension buffers.

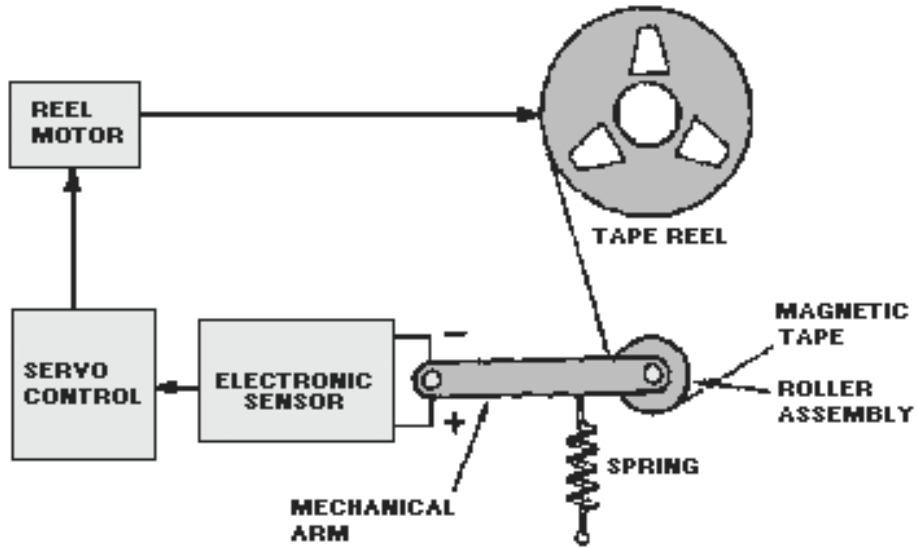

Figure 4-3.—Mechanical arm spring-tension tape buffering.

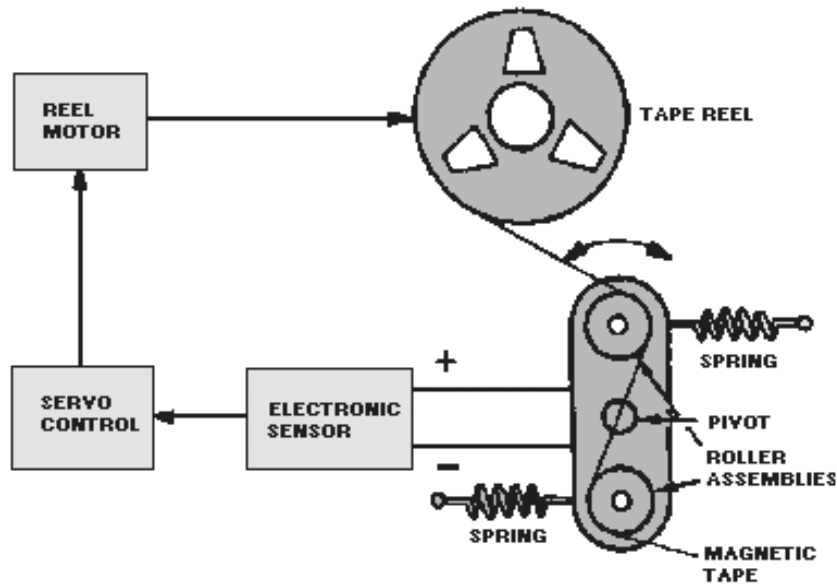

Figure 4-4.—Mechanical arm spring-tension tape buffering.

2. **Vacuum-column** buffering systems operate like the spring-tension systems. They also regulate the speed control servos that control tape reel speed. But, as shown in figure 4-5, the vacuum-column buffer system uses a vacuum chamber instead of a spring to hold a length of magnetic tape as *slack* during tape recorder starts and stops. An electronic sensor in the vacuum chamber helps to control how much tape is in the buffer.

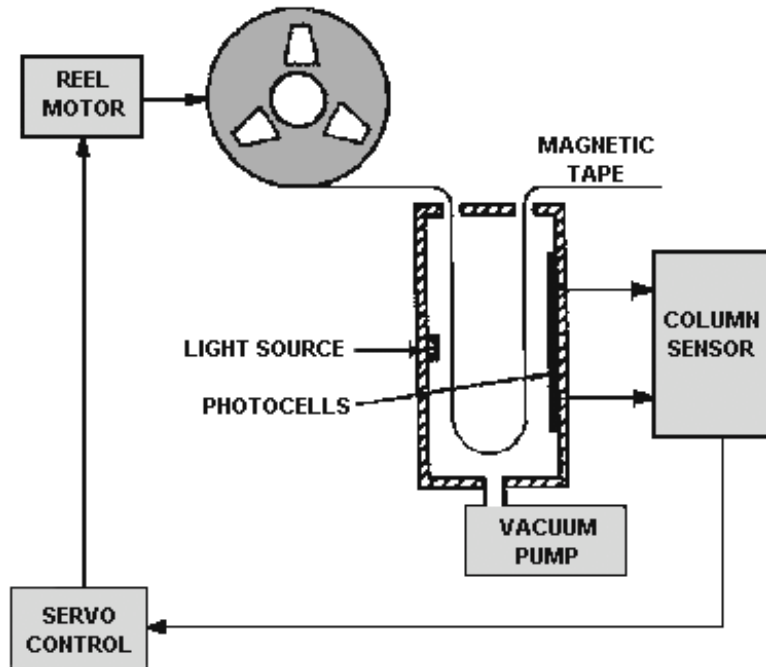

Figure 4-5.—Vacuum-column tape buffering system.

## TAPE GUIDES

Another job of a tape reeling system is to make sure the magnetic tape is protected from damage during operation. To do this, tape reeling systems use tape guides. Tape guides come in two designs, *fixed* and *rotary*. Both of these are shown in figure 4-6. Each type of tape guide has its drawbacks. Fixed tape guides produce a lot more friction, and rotary tape guides are more likely to cause errors because of their moving parts.

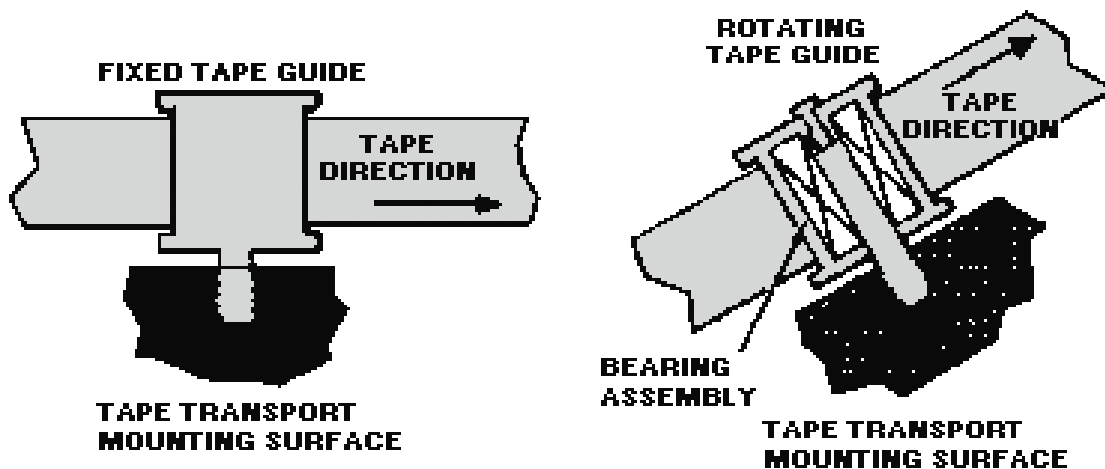
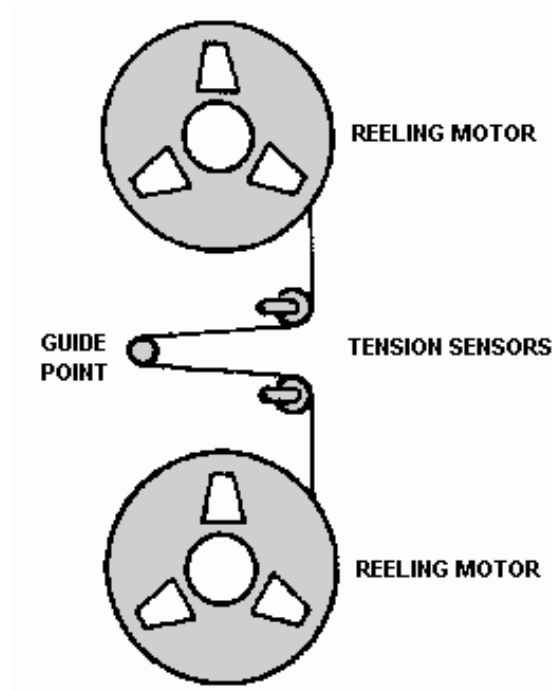

Figure 4-6.—Typical fixed and rotary tape guides.

Tape guides are strategically placed in a tape reeling system to make sure the magnetic tape is kept straight with respect to the supply and take-up reels and the magnetic heads. Some magnetic recorders use only fixed tape guides, some use rotary tape guides, and some use a combination of the two.

### **TAPE REELING CONFIGURATIONS**

There are two basic tape reeling configurations: (1) co-planar, and (2) co-axial. Both of these describe the physical relationship between the supply reel and the take-up reel. The co-planar, which is used more often than the co-axial, has the supply reel and the take-up reel side by side. Figure 4-7 shows this configuration.



**Figure 4-7.—Co-planar tape reeling configuration.**

The co-axial configuration is used when physical space is limited. It places the supply and take-up reels on top of each other. Figure 4-8 shows this configuration.



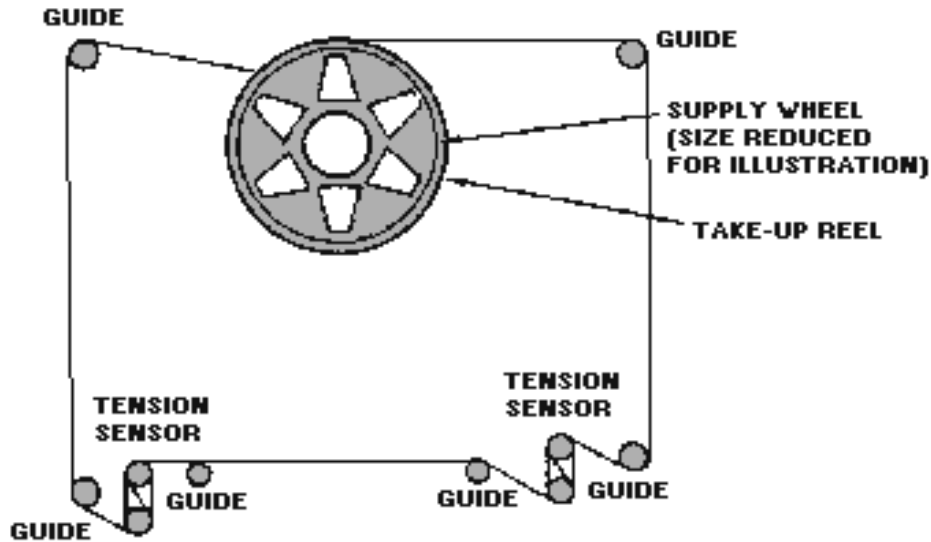

Figure 4-8.—Co-axial tape reeling configuration.

- Q-1. What are the four basic parts of a magnetic tape recorder's tape transport system?
- Q-2. What are the three most commonly used tape reeling systems?
- Q-3. What are two disadvantages of the take-up control reeling system?
- Q-4. What are two advantages of a two-motor reeling system over a take-up control reeling system?
- Q-5. What type of reeling system best controls a tape recorder's tape tension during starts and stops?
- Q-6. What are the two basic types of tape buffering reeling systems?
- Q-7. How do the tape guides on a tape reeling system protect the tape from damage during operation?

## TAPE TRANSPORT CONFIGURATIONS

There are two types of tape transport configurations: (1) *open-loop capstan drive*, and (2) *closed-loop capstan drive*. The following paragraphs describe each of these.

### OPEN-LOOP CAPSTAN DRIVE

This is probably the simplest tape transport configuration. Figure 4-9 shows how the magnetic tape is pulled off of the supply reel, taken across the magnetic heads, and wound onto the take-up reel. The tape is *pulled* by sandwiching it between a single capstan and a pinch roller. As the capstan turns, the friction between it and the pinch roller pulls the tape across the magnetic heads. The magnetic tape is held against the magnetic heads by using tape guides.

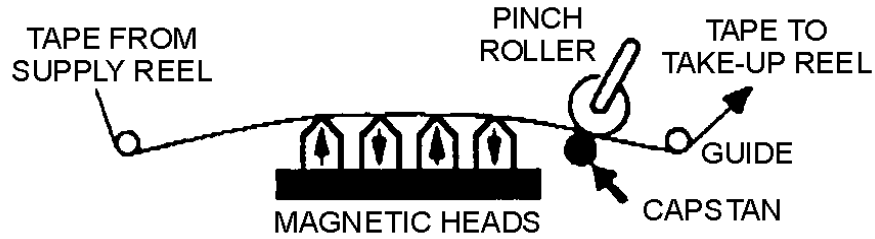

Figure 4-9.—Open-loop capstan drive tape transport.

The open-loop drive transport configuration has two major drawbacks:

1. It can only work in one direction. It can *pull* the tape, but it can't *push* it across the magnetic heads.
2. Tape tension and head-to-tape contact can vary. If the capstan motor hesitates or speeds up, the tape tension will vary.

### CLOSED-LOOP CAPSTAN DRIVE

Closed-loop capstan drive tape transports were designed to overcome the drawbacks of the open-loop drive design. They use more than one capstan and/or pinch roller to *clamp* the magnetic tape in the area around the magnetic heads. This keeps tape tension constant and improves the quality of the recording or the playback. Figure 4-10 shows the basic arrangement of the closed-loop capstan drive.

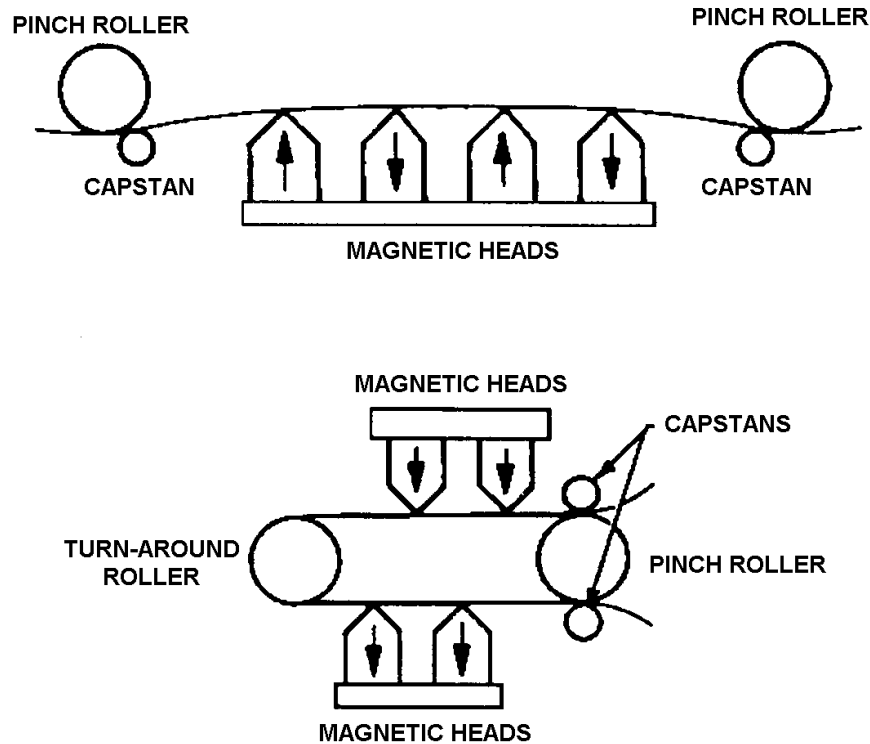

Figure 4-10.—Closed loop capstan drive tape transport.

The three most common closed-loop capstan drive designs are (1) *differential velocity capstans*, (2) *dual-motors dual capstans*, and (3) *peripheral drive capstans*.

### Differential Velocity Capstans

Figure 4-11 shows a differential velocity capstan. In this design, the take-up capstan is made a little larger than the supply capstan. This causes the take-up capstan to pull the tape away from the heads slightly faster than the supply capstan feeds the tape to the heads. The result is a constant tape tension in the area around the magnetic heads.

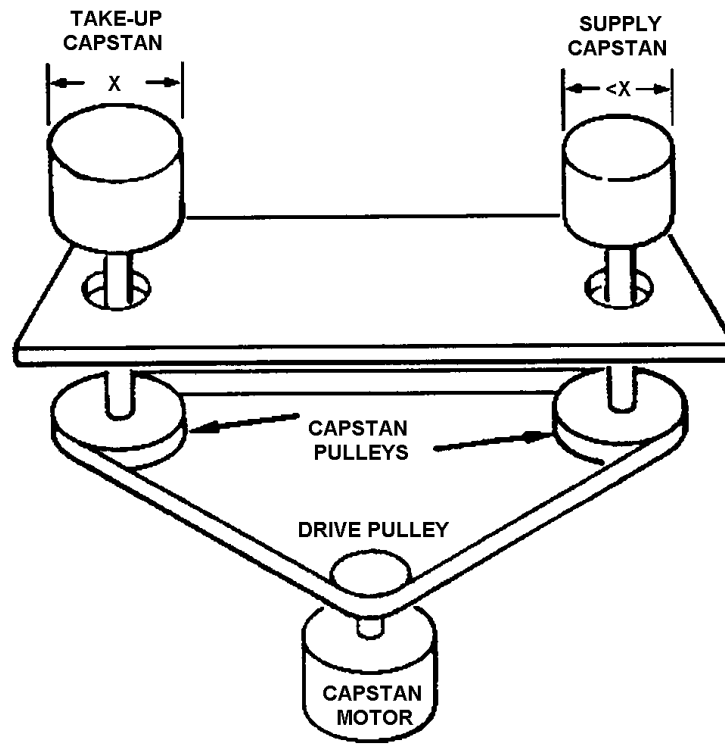

Figure 4-11.—Differential velocity capstan drive.

Both capstans are turned by a single motor which is coupled to the capstan pulleys by a belt. This arrangement is very efficient in one direction, but, unfortunately, differential velocity capstans don't work in reverse. If you reversed the tape direction, a negative tension would occur, and the tape would bunch up in the area around the magnetic heads.

### Dual-Motors Dual Capstans

Figure 4-12 shows a dual-motor dual capstan drive. In this design, each capstan is driven by its own motor. Tape tension is maintained by slowing down one of the motors. When reverse tape motion is needed, the opposite motor is slowed down.

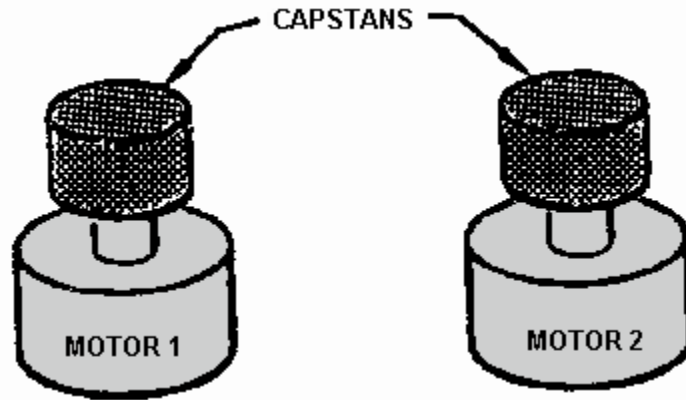

Figure 4-12.—Dual-motors dual capstans drive system.

### Peripheral Drive Capstans

In this design, the magnetic tape is moved by a capstan placed directly against the tape reel or tape pack. Figure 4-13 shows two different peripheral drive capstan arrangements.

The first arrangement, figure 4-13A, shows a single capstan design. In this method, two tightly wound tape reels, without flanges, are pushed against the capstan. As the capstan turns, it forces the tape reels to turn in the appropriate direction. Magnetic tape tension is maintained by using either spring loading or servo control.

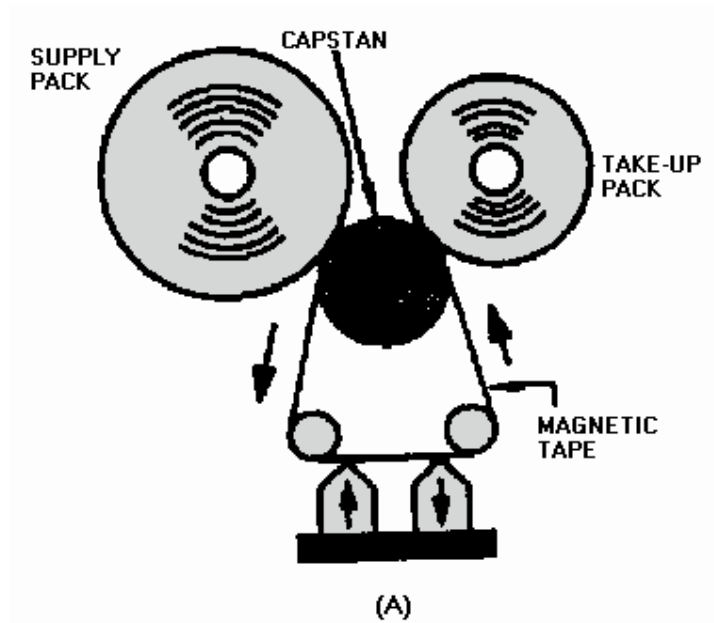

Figure 4-13A.—Peripheral drive capstans.

The second arrangement, figure 4-13B, uses two capstans. In this method, the two tightly wound tape reels, without flanges, are pressed directly against the capstans. Tension in the magnetic head area is maintained by controlling the speed of the individual capstans.

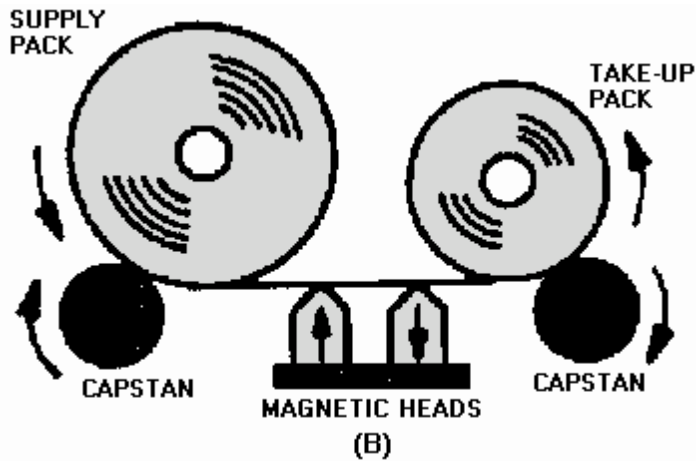

Figure 4-13B.—Peripheral drive capstans.

### CAPSTAN SPEED CONTROL

Capstan speed control is an important part of the magnetic tape transport system. It makes sure the capstan is turning (1) at the right speed and (2) at a constant speed. This is important because errors in speed control can cause poor recordings and playbacks.

Capstans are turned either by a motor only, or by a motor, belt, and pulley arrangement. In either case, it's the motor that the capstan speed control function acts upon to do its job. A capstan speed control function typically consists of six basic parts. Figure 4-14 shows these six parts and how they're related. Each of the parts is described below.

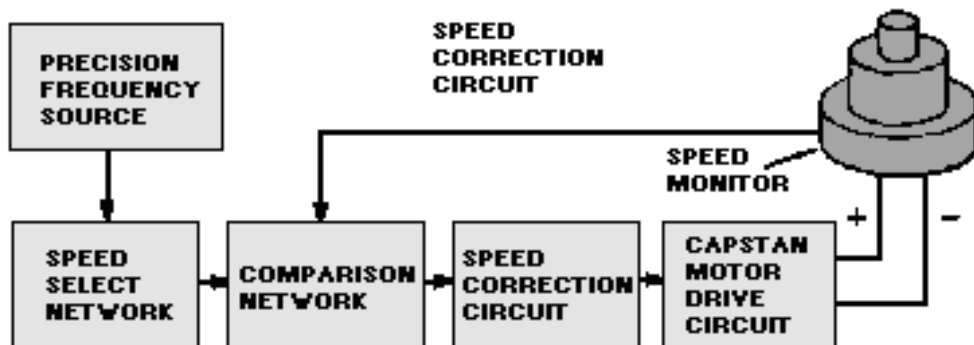

Figure 4-14.—Six parts of the capstan speed control function.

#### PRECISION FREQUENCY SOURCE

This part of the capstan speed control provides a reference frequency that the *speed select network* and the *comparison network* use to drive the capstan motor. The precision frequency source is usually a very-high-frequency crystal with an accuracy of at least .001 percent.

## SPEED SELECT NETWORK

This network selects the desired operating tape speed. It takes the reference frequency from the *precision frequency source* and (depending on the desired operating tape speed) generates another specific reference signal that the *comparison network* uses to control the speed of the capstan. Table 4-1 is a list of the speed control reference signal frequencies for the various operating tape speeds.

Table 4-1.—Typical speed control reference signal frequencies

<u>Operating Tape Speed</u> (inches per second)	<u>Speed Control Frequency</u> (kilohertz)
15/16	1.5625
1 7/8	3.125
3 3/4	6.25
7 1/2	12.5
15	25
30	50
60	100
120	200
240	400

## CAPSTAN SPEED MONITOR

This circuit monitors the true capstan motor speed. It sends the true speed to the *comparison network* circuit. Most capstan speed monitor circuits are made using a photo-optical tachometer that's directly attached to the shaft of the capstan motor. Figure 4-15 shows this.

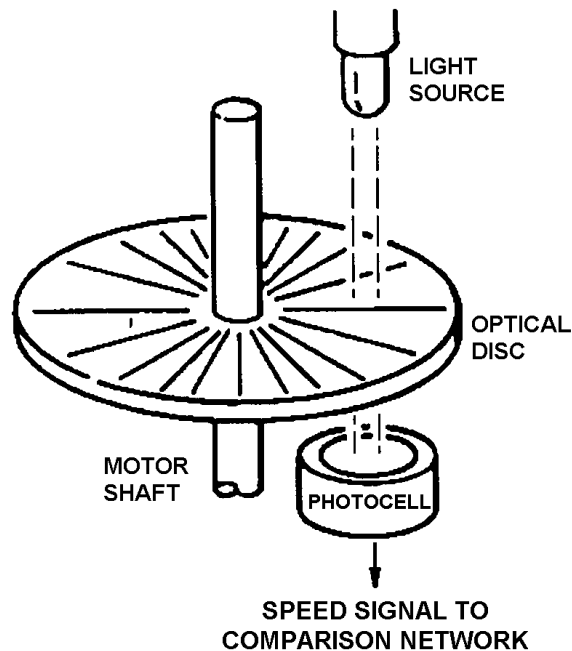

Figure 4-15.—Capstan speed monitor using a photo-optical tachometer.

## COMPARISON NETWORK

This network takes the input signals from the *speed select network* and the *capstan speed monitor*, compares the two signals, and decides if the capstan is at the right speed. If not, it tells the *speed correction circuit*.

Sometimes, a third input signal, which comes from the magnetic tape itself, is supplied to the *comparison network*. It's called a *servo control from tape signal*. Tape recordings made on a specific recorder are sometimes shipped off for further analysis and played back on a different recorder. To help compensate for speed errors in the tape transport systems of the two recorders, the *precision reference frequency* of the originating recorder is recorded onto a track of the magnetic tape. During playback, this reference signal is also fed to the recorder's *comparison network* and is used to correct speed errors.

## SPEED CORRECTION CIRCUIT

This circuit takes speed correction signals from the *comparison network* and tells the *capstan motor drive circuit* to either speed up or slow down the capstan motor.

## CAPSTAN MOTOR DRIVE CIRCUIT

This circuit takes the speed-up or slow-down signals from the speed correction circuit and actually speeds up or slows down the capstan motor.

## MAGNETIC TAPE TRANSPORT MAINTENANCE

If you want good recordings and playbacks, you must keep magnetic tape transports clean and demagnetized. The following paragraphs describe preventive maintenance procedures for magnetic tape transport systems.

### MAGNETIC TAPE TRANSPORT CLEANING

You can clean most magnetic tape transports with isopropyl alcohol, cotton swabs, and lint-free cloths. (Caution: Cotton swabs are not lint free, so use them only in places you can't get to with the lint-free cloths.) Figure 4-16 shows a technician cleaning a capstan. Here are some other points to remember:

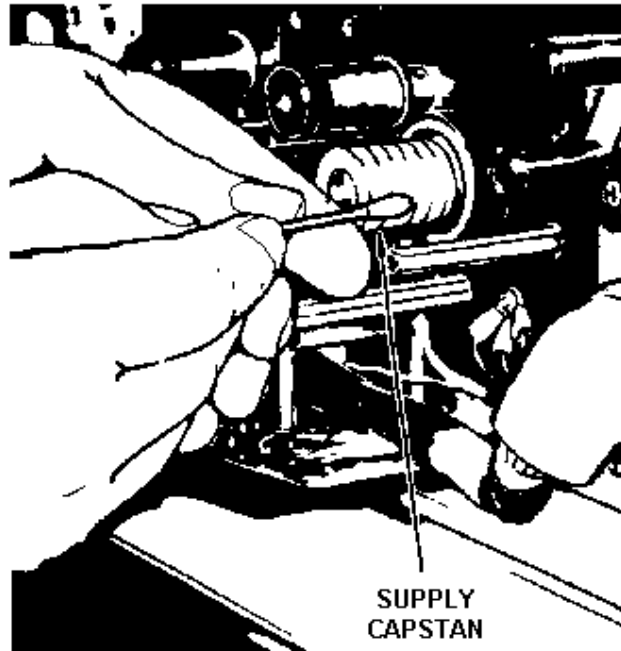

Figure 4-16.—Cleaning the capstan on a magnetic tape transport system.

- DO always remove the magnetic tape from the transport before cleaning it.
- DO apply the cleaner onto the lint free cloth or cotton swab; DON'T apply it directly onto the tape transport.
- DO pay extra attention to the flanged parts of tape guides. It's here that oxide particles collect the most.
- DON'T use the same lint-free cloth or cotton swab to clean many parts of the tape transport. Switch cloths and swabs often. If you don't, you may transfer dirt and oxide particles from one part of the tape transport to another.

### MAGNETIC TAPE TRANSPORT DEMAGNETIZING

With use, tape transport parts become magnetized. It's hard to say *exactly* what will happen if the magnetic tape passes a magnetized part of the tape transport before the tape is recorded on. The effects can range from just a little more noise on the tape to a complete tape saturation. Either way, magnetized tape transport parts can ruin magnetic recordings.

To prevent this, you must periodically demagnetize the tape transport. The procedures for doing this are identical to those listed in chapter 2 for demagnetizing magnetic heads. You'll even use the same manual hand-held degausser you saw in figure 2-8 of chapter 2. Figure 4-17 shows a technician demagnetizing a tape guide.



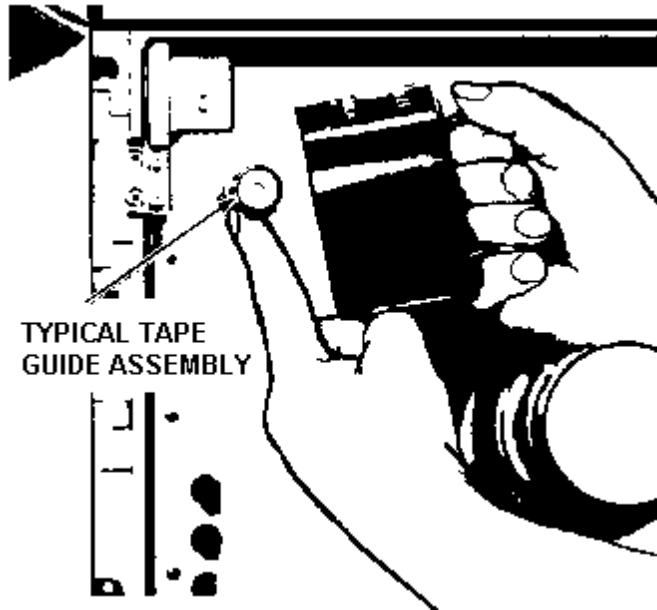

Figure 4-17.—Demagnetizing a tape guide with a hand-held degausser.

- Q-8. *There are two types of tape transport configurations, open-loop capstan drive and closed-loop capstan drive. What are two major disadvantages of open-loop capstan drive tape transports?*
- Q-9. *How do closed-loop capstan drive tape transports overcome the disadvantages of the open-loop drive design?*
- Q-10. *What are the three most common closed-loop capstan drive designs?*
- Q-11. *How do tape transports with differential velocity capstans maintain a constant tape tension in the area around the magnetic heads?*
- Q-12. *How do dual-motor dual capstan drives maintain a constant tape tension while operating in either a forward or reverse direction?*
- Q-13. *What are the two critical functions of the capstan speed control part of a magnetic tape transport system?*
- Q-14. *Which part of the capstan speed control function monitors the true capstan motor speed?*
- Q-15. *Sometimes it's necessary, but why should you avoid using cotton swabs when cleaning a magnetic tape transport?*
- Q-16. *When cleaning the parts of a tape transport, why should you switch lint-free cloths and swabs often?*
- Q-17. *What equipment should you use to de-magnetize a magnetic tape transport?*

## SUMMARY

Now that you've finished chapter 4, you should be able to describe magnetic tape transport systems in terms of their operating characteristics, parts, and preventive maintenance requirements. The following is a summary of the important points in this chapter.

A **MAGNETIC TAPE RECORDER TRANSPORT** has four basic parts: (1) tape reeling system, (2) tape speed control system, (3) electronic subsystem, and (4) basic enclosure.

The **TAPE REELING SYSTEM** must move the tape in a straight line at a constant tension, and it must start and stop smoothly while maintaining the proper tension.

Three of the **MOST COMMON REELING SYSTEMS** are (1) take-up control, (2) two-motor reeling, and (3) tape buffering.

The two types of **TAPE TRANSPORT CONFIGURATIONS** are (1) *open-loop capstan drive* and (2) *closed-loop capstan drive*. The open-loop type works in only one direction, and the tape tension can vary. The closed-loop type keeps the tape tension constant.

Three types of **CLOSED-LOOP CAPSTAN DRIVES** are (1) differential velocity capstans, (2) dual-motors dual capstans, and (3) peripheral drive capstans.

The **CAPSTAN SPEED CONTROL** component of a tape transport keeps the capstan turning at the correct operating speed and at a constant speed. It has these six parts: (1) precision frequency source, (2) speed select network, (3) capstan speed motor, (4) comparison network, (5) speed correction circuit, and (6) capstan motor drive circuit.

You should **CLEAN** magnetic tape transports with isopropyl alcohol, cotton swabs, and lint free cloths and **DEMAGNETIZE** them using a hand-held degausser.

## ANSWERS TO QUESTIONS Q1. THROUGH Q17.

A1.

- a. *Tape reeling system.*
- b. *Tape speed control system.*
- c. *Electronic subsystem.*
- d. *Basic enclosure.*

A2.

- a. *Take-up control.*
- b. *Two-motor reeling.*
- c. *Tape buffering.*

- A3.
- a. *It only works in one direction.*
  - b. *The tape tension varies as the supply reel unwinds, which can cause damage during starts and stops.*
- A4. *The two-motor configuration runs in both directions and a holdback voltage helps control tape tension, but it does not properly control tape tension during starts and stops.*
- A5. *A tape buffering reeling system.*
- A6.
- a. *Spring-tension **buffering systems**.*
  - b. *Vacuum-column **buffering systems**.*
- A7. *They keep the tape straight with respect to both the supply and take-up reels and the magnetic heads.*
- A8.
- a. *Only operates in one direction.*
  - b. *The tape tension and head-to-tape contact can vary.*
- A9. *Closed loop capstan drive transports use more than one capstan to clamp the tape in the area around the magnetic head.*
- A10.
- a. *Differential velocity capstans.*
  - b. *Dual motors dual capstans.*
  - c. *Peripheral drive capstans.*
- A11. *The supply capstan is slightly larger than the take-up capstan. This causes the take-up capstan to pull the tape slightly faster than the supply capstan feeds the tape.*
- A12. *Each capstan is driven by its own motor. It maintains tape tension by slowing down one of the motors. When the tape motion is reversed, the opposite motor is slowed down.*
- A13. *Makes sure the capstan turns at the right speed and at a constant speed.*
- A14. *Capstan speed monitor.*
- A15. *Cotton swabs are not lint free.*
- A16. *You may transfer dirt or oxide particles from one part of the tape transport to another.*
- A17. *A hand-held degausser.*



## CHAPTER 5

# MAGNETIC TAPE RECORDER RECORD AND REPRODUCE ELECTRONICS

### LEARNING OBJECTIVES

After completing this chapter, you'll be able to do the following:

1. State the two types of record and reproduce electronics used on magnetic tape recorders.
2. Describe the purpose and function of *direct record* electronics and the four main parts of a recorder's direct record component.
3. Describe the purpose and function of *direct reproduce* electronics and the three main parts of a recorder's direct reproduce component.
4. Describe the purpose and function of *frequency modulation* (FM) record electronics and the three main parts of a recorder's FM record component.
5. Describe the purpose and function of FM reproduce electronics and the four main parts of a recorder's FM record component.

### RECORD AND REPRODUCE ELECTRONICS

There are two ways to record and reproduce analog signals. The first way is *direct record*. It's also called *amplitude modulation* (AM) electronics. The second way is *frequency modulation* (FM). Even though direct record and reproduce circuits are much different from FM record and reproduce electronics, they both share the same two very important jobs. They both must:

1. Take an input signal, process it as needed, and then send it to the record magnetic head for reproduction.
2. Take the reproduced signal from the reproduce magnetic head, process it as needed, and output it for listening or analysis.

### DIRECT RECORD ELECTRONICS

Direct record electronics record input signals onto magnetic media just as the signals appeared at the recorder's input. The only processing an input signal receives is the adding of a bias signal. The added bias signal makes sure the signal stays away from the *steps* of the magnetism curve. Figure 5-1 shows a basic block diagram of a recorder's direct record electronics.

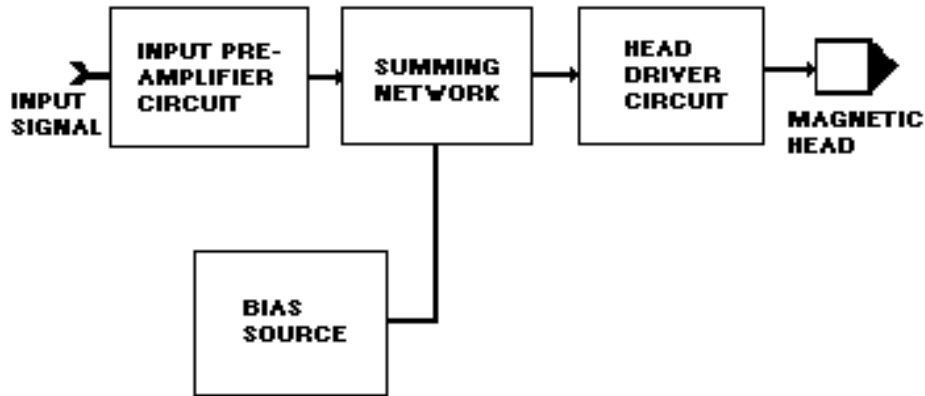

Figure 5-1.—Direct record electronics.

Direct record electronics has four main parts:

1. Input pre-amplifier circuit. This circuit takes the input signal, amplifies it, and sends it to the summing network. It also matches the impedance between the source of the input signal and the magnetic tape recorder.
2. Bias source. This circuit generates the high-frequency bias signal and sends it to the summing network. Normally, the frequency of the bias signal will be five to ten times higher than the highest frequency the tape recorder can record.
3. Summing network. This network takes the input signal and the bias signal, mixes them, and sends the resulting signal to the head driver circuit.
4. Head driver circuit. This circuit takes the signal from the summing network, amplifies it, and sends it to the record head for recording.

## DIRECT REPRODUCE ELECTRONICS

Direct reproduce electronics amplify the *very* weak input signals from the reproduce head, and send them out for listening or analysis, as needed. Figure 5-2 shows a basic block diagram of direct reproduce electronics.

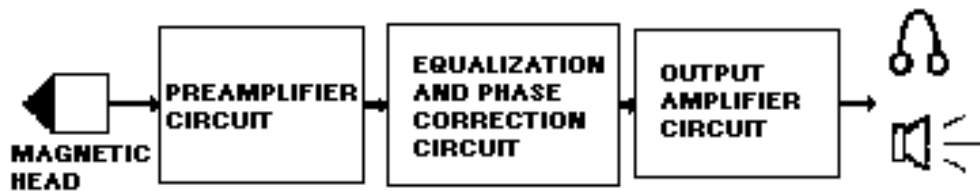
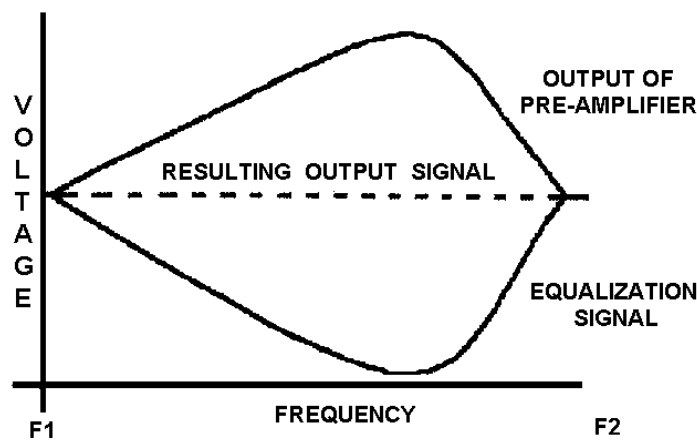

Figure 5-2.—Direct reproduce electronics.

Direct reproduce electronics consists of three main parts:

1. **Pre-amplifier circuit.** This circuit takes the very weak reproduced signal from the reproduce head and (a) amplifies the signal, (b) removes any bias signal that was used during the recording process, and (c) sends the signal to the equalization and phase correction circuit.
2. **Equalization and phase correction circuit.** This circuit takes the pre-amplified signal and fixes any frequency response problems that the reproduce magnetic head may have caused. To better understand this, look at the voltage *versus* frequency response graph in figure 5-3. The top of the graph shows the input signal that comes from the pre-amplifier and the bottom shows the *equalization* signal generated by the equalization circuit. In the top part of the graph, note how the output voltage level varies as the frequency of the signal varies. This isn't good. A good output voltage level is one that remains constant as the frequency changes. The equalization signal corrects this problem. Notice that when the input signal and the equalization signal are combined they cancel each other out. This allows a nice flat (voltage *versus* frequency) output signal to go to the output amplifier circuit.



Courtesy of DATATAPE Incorporated, Copyright © All rights reserved

Figure 5-3.—Equalization process.

3. **Output amplifier circuit.** This circuit takes the signal from the equalization and phase correction circuit and amplifies it for output. It also matches the magnetic recorder's impedance to the output device that is used for listening or recording.

## FM RECORD ELECTRONICS

FM record electronics process signals to be recorded differently than direct record electronics. Instead of recording the input signal just as it appears at the recorder's input, FM record electronics use the input signal to vary (modulate) the carrier frequency of a *record oscillator*. The frequency modulated output signal of the *record oscillator* then becomes the signal that's actually recorded onto the magnetic media. Figure 5-4 shows a block diagram of the FM record electronics.



Figure 5-4.—FM record electronics.

FM record electronics consist of three main parts:

1. Input pre-amplifier circuit. This circuit does two things: (a) it serves as an impedance matcher between the signal source and the magnetic recorder, and (b) it pre-amplifies the input signal.
2. Record oscillator circuit. This circuit generates a carrier signal onto which the input signal will be modulated. The input signal is used to vary (frequency modulate) the carrier signal. This is how the input signal gets frequency modulated onto the carrier signal. The output of this circuit is the frequency-modulated carrier signal. The center frequency of the carrier depends on two things: (a) the bandwidth of the signal you're recording, and (b) the media onto which you're recording. For magnetic tape, the carrier frequency can be as low as 1.688 kHz for an operating tape speed of 1-7/8 inches per second, and as high as 900 kHz for 120 inches per second.
3. Head driver circuit. This circuit takes the frequency-modulated output from the record oscillator circuit, amplifies it, and sends it to the magnetic head for recording. The output level of this circuit is set to be *just below* the magnetic saturation point of the magnetic media.

## FM REPRODUCE ELECTRONICS

The FM reproduce electronics work just like direct reproduce electronics, with one exception. FM reproduce electronics must first demodulate the original input signal from the carrier frequency before the intelligence can be sent to the output device for listening or analysis. Figure 5-5 shows a block diagram of the FM reproduce electronics.

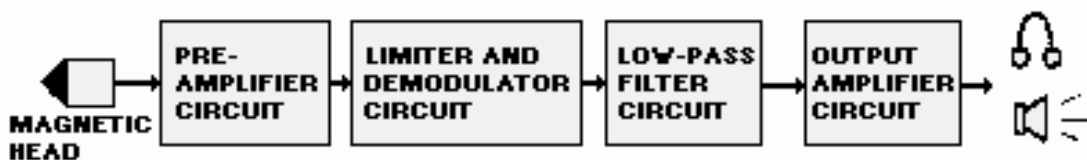

Figure 5-5.—FM reproduce electronics.

FM reproduce electronics consist of four main parts:

1. Pre-amplifier circuit. This circuit takes the frequency modulated carrier frequency from the reproduce head and amplifies it.
2. Limiter/demodulator circuit. This circuit takes the output of the preamplifier, stabilizes the amplitude level, and demodulates the signal intelligence from the carrier frequency.



3. Low-pass filter circuit. This circuit takes the signal intelligence from the limiter/demodulator circuit and cleans up any noise or left over carrier signal.
4. Output amplifier circuit. This circuit takes the output from the low-pass filter and amplifies it for output. It also matches the impedance of the magnetic recorder to the output device.

- Q-1. What two types of record and reproduce electronics are used by magnetic tape recorders?*
- Q-2. The head driver circuit in a tape recorder's direct record electronics component (figure 5-1) performs what function?*
- Q-3. The equalization and phase correction circuit in a tape recorder's direct reproduce electronics (figure 5-2) performs what function?*
- Q-4. How do FM record electronics differ from AM (direct record) electronics?*
- Q-5. The head driver circuit of a tape recorder's FM record electronics (figure 5-4) performs what function?*
- Q-6. What is the major difference between direct reproduce electronics and FM reproduce electronics?*

## SUMMARY

Now that you've finished chapter 5, you should be able to (1) state the two types of record and reproduce electronics used on magnetic tape recorders and (2) describe the function and main parts of *direct record and reproduce electronics* and *FM record and reproduce electronics*. The following is a summary of important points in this chapter:

**DIRECT RECORD (AM)** and **FREQUENCY MODULATION (FM)** are the two types of record and reproduce electronics used by magnetic tape recorders.

The four main parts of **DIRECT RECORD ELECTRONICS** are the (1) input pre-amplifier circuit, (2) bias source, (3) summing network, and (4) head driver circuit.

The three main parts of **DIRECT REPRODUCE ELECTRONICS** are the (1) pre-amplifier circuit, (2) equalization and phase correction circuit, and (3) output amplifier circuit.

**FM RECORD ELECTRONICS** record a frequency modulated signal onto the magnetic tape. It has three main parts: (1) input pre-amplifier circuit, (2) record oscillator circuit, and (3) head driver circuit.

**FM REPRODUCE ELECTRONICS** must demodulate the original input signal from the carrier signal. It has four main parts: (1) preamplifier circuit, (2) limiter and demodulator circuit, (3) low-pass filter circuit, and (4) output amplifier circuit.

## ANSWERS TO QUESTIONS Q1. THROUGH Q6.

A1.

- a. *Direct record (AM).*
- b. *Frequency modulation (FM).*

A2. *It takes the signal from the summing network, amplifies it, and sends it to the record head for recording.*

A3. *It generates an equalization signal which corrects any frequency response problems in the input signal from the pre-amplifier circuit.*

A4. *Instead of recording the signal just as it appears at the recorder's input, FM record electronics records a frequency-modulated carrier signal from a record oscillator (figure 5-4) onto the magnetic tape.*

A5. *It amplifies the frequency-modulated output from the record oscillator and sends it to the record head.*

A6. *FM record electronics must use a limiter and demodulator circuit (figure 5-5) to demodulate the signal intelligence from the carrier frequency.*

# CHAPTER 6

## MAGNETIC TAPE RECORDING SPECIFICATIONS

### LEARNING OBJECTIVES

After completing this chapter, you'll be able to do the following:

1. Define the seven most common magnetic tape recording specifications.
2. Describe a magnetic tape recorder's *signal-to-noise ratio* (SNR) *specification*, how it's measured, and why a high SNR is important.
3. Describe a tape recorder/reproducer's *frequency-response* specification, how it's measured, and the three factors that can limit or degrade a recorder's frequency response.
4. Describe a tape recorder's *harmonic-distortion* specification, how it's measured, and how a recorder produces harmonic distortion.
5. Describe a recorder's *phase-response* specification, how it's measured, and why good phase response is important.
6. Describe a recorder's *flutter* specification, how it's measured, and why minimal flutter is important.
7. Describe a recorder's *time-base error* (TBE) specification, how it's measured, and why minimal TBE is important.
8. Describe a multi-track magnetic tape recorder's *skew* specification, how it's measured, and why minimal skew is important.

### INTRODUCTION

Have you ever gone to a store to buy a magnetic tape recorder? Were you able to decide which of the displayed models was the *good* one to buy? Or, did you instead end up confused when the salesperson started spouting words like *SNR*, *flutter*, and *bandwidth*. If so, you weren't alone.

This chapter (1) defines the seven most common magnetic tape recording specifications, (2) describes their effect on the magnetic recording process, and (3) tells how to measure each specification. The remaining paragraphs in this chapter describe each of the following magnetic tape recorder specifications:

1. Signal-to-noise ratio
2. Frequency response
3. Harmonic distortion
4. Phase response

5. Flutter
6. Time-base error
7. Skew

## SIGNAL-TO-NOISE RATIO

Signal-to-noise ratio (SNR) is the first magnetic tape recorder specification we'll describe. It's one of the most important specifications of a magnetic tape recorder.

### SIGNAL-TO-NOISE RATIO DEFINITION

The SNR is *the ratio of the normal signal level to the magnetic tape recorder's own noise level*. It's measured in decibels (dB). In other words, the higher the SNR of a magnetic tape recorder, the wider the range of input signals it can properly record and reproduce.

The *noise* part of the signal-to-noise ratio is generated in the magnetic tape recorder itself. Although noise can be generated by almost any part of the magnetic tape recorder, it's usually generated by either the magnetic heads or the magnetic tape.

### SIGNAL-TO-NOISE RATIO MEASUREMENT

You can measure the SNR with a vacuum tube voltmeter (VTVM) and a signal generator. The equipment set up for measuring the SNR is shown in figure 6-1. After equipment setup, measure the SNR as follows:

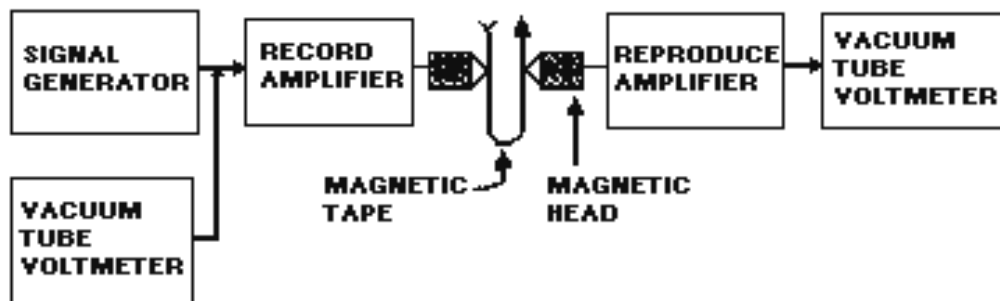

Figure 6-1.—Test equipment setup for measuring signal-to-noise ratio.

1. Set the signal generator to inject a test signal into the tape recorder. The technical manual for the tape recorder you're testing will tell you how to set up the signal generator.
2. While recording and reproducing, set the output level of the tape recorder's reproduce electronics to a level that displays 0-dB reference on the VTVM.
3. Disconnect the signal generator. The voltage displayed on the VTVM will drop from 0-dB to some *negative* dB level. This level is the magnetic tape recorder's SNR.

There are two things you should know when reading SNR specifications in technical manuals, equipment brochures, etc.

First, the SNR is stated in three ways. You'll see it as (1) *root-mean-square (RMS) signal-to-RMS noise*, (2) *peak-to-peak signal-to-RMS noise*, or (3) *peak signal-to-RMS noise*. If the SNR specification doesn't state which way it was measured, you could be misled. For example, a 25-dB RMS SNR is equal to a 34-dB peak-to-peak signal-to-RMS noise ratio, or a 28-dB peak signal-to-RMS noise ratio.

Second, all SNR specifications should include the record level that was used. Since the SNR varies directly to the record level, you could be misled by a SNR that doesn't include the record level of the test signal used when the SNR was measured.

## FREQUENCY RESPONSE

The frequency-response specification of a magnetic tape recorder is sometimes called the *bandwidth*. A typical frequency-response specification might read *within + / - 3 db from 100 Hz to 100 kHz at 60 ips*. This means the magnetic tape recorder is capable of recording all frequencies between 100 Hz and 100 kHz at 60 inches per second (ips) without varying the output amplitude more than 3 dB.

### FREQUENCY-RESPONSE DEFINITION

Frequency response is *the amplitude variation with frequency over a specified bandwidth*. Let's convert this to plain English. The frequency-response specification of a magnetic tape recorder tells you the range of frequencies the recorder can *effectively* record and reproduce. What exactly does the word *effectively* mean? That's hard to say because frequency response varies from recorder to recorder, and from manufacturer to manufacturer. But a good rule of thumb is that *an effective frequency-response specification tells the lowest and highest frequencies that the recorder can record and reproduce with no more than + / - 3-dB difference in output amplitude*.

### FREQUENCY-RESPONSE MEASUREMENT

The equipment setup for measuring the frequency response of a magnetic tape recorder is the same as for measuring the signal-to-noise ratio. It's shown in figure 6-1. After equipment setup, measure a recorder's frequency response as follows:

1. Set the signal generator to output a test signal. The technical manual for the tape recorder will tell you how.
2. Set the recorder's reproduce electronics output level to a 0-dB reference on the VTVM.
3. While recording at a set speed, vary the frequency of the signal generator from the lowest to highest frequency you're checking. Make sure that the output level of the signal generator stays the same.
4. As you sweep through the frequencies, look at the VTVM. You'll see the amplitude rise and fall as you vary the output frequency of the signal generator. As you approach the lowest and the highest frequencies that the magnetic tape recorder can *effectively* record, you'll see the VTVM drop to less than - 3 dB. This determines the lower and upper limits of the frequency-response specification for that magnetic tape recorder.

## FREQUENCY-RESPONSE LIMITING FACTORS

Four factors that can limit or degrade the frequency response of magnetic tape recorders are:

1. A too-high or too-low bias signal level setting for the record head.
2. An improper reproduce head.
3. An improper tape transport speed.
4. A poor magnetic tape-to-head contact.

The magnetic record head transforms the electrical signal into a magnetic field for recording onto magnetic tape. If the bias signal level is set to high, you might erase the higher frequencies. If it's too low, you'll get excessive tape distortion.

The reproduce head transforms the magnetic field from the magnetic tape back into an electrical signal. As explained in chapters 3 and 5, the head gap of a recorder's reproduce head and the operating speed of the magnetic tape transport determine the wavelength of the reproduce head. The wavelength determines the *center* frequency of a recorder's frequency-response specification. Once you pass this center frequency, both below and above, the output voltage level of the recorder's reproduce head will decrease. Figure 6-2 shows this. This is why the equalization circuits described in chapter 5, figure 5-3, are used.

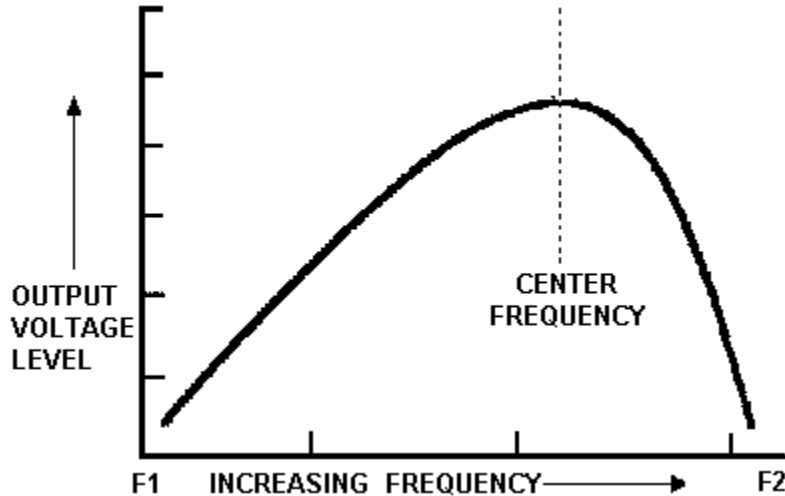
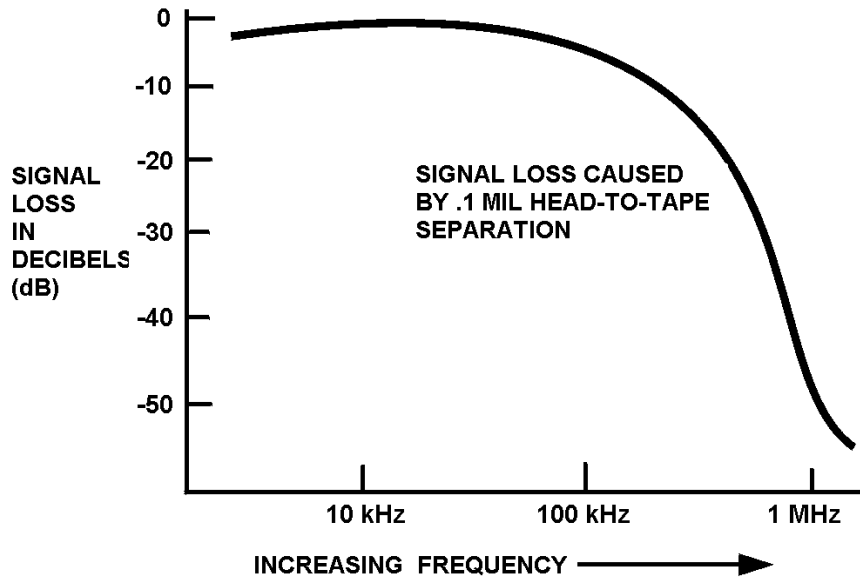

Figure 6-2.—Frequency response of a reproduce head.

Poor tape-to-head contact can seriously degrade the record and reproduce process. Magnetic heads are designed to reduce tape-to-head gap as much as possible. A tape-to-head gap is *extremely* degrading at the higher frequencies. Figure 6-3 shows this. Note how a .1-mil gap causes only a small loss at 10 kHz. But, at 1 MHz, it causes a 46-dB loss! You must maintain tape-to-head contact. Keeping the magnetic tape recorder heads and tape transport clean is the best way to do this.



*Courtesy of DATATAPE Incorporated, Copyright © All rights reserved*

**Figure 6-3.—Effects of poor tape-to-head contact.**

- Q-1. Two tape recorders have signal-to-noise ratios (SNRs) of 25-dB RMS and 35-dB RMS respectively. Which of the SNRs can record and reproduce the widest range of input signals and why?*
- Q-2. You plan to measure your tape recorder's SNR. What test equipment will you need?*
- Q-3. Technical manuals for tape recorders can state the SNR in what three different ways?*
- Q-4. The frequency-response specification of your tape recorder reads within  $\pm 3$  dB from 150 Hz to 150 kHz at 60 ips. What does this mean?*
- Q-5. While measuring frequency response, as the signal generator approaches the lowest and highest frequency the recorder can effectively record, the VTVM reading drops to less than  $-3$  dB. What does this indicate?*
- Q-6. List four factors that can degrade the frequency response of magnetic tape recorders.*

## HARMONIC DISTORTION

A magnetic tape recorder's harmonic-distortion specification is very important. It usually determines where the record level of a recorder's electronics should be set. The record level is also used to determine the signal-to-noise ratio and frequency-response specifications. A typical harmonic-distortion specification might read "1% third harmonic of a 100-kHz signal at 60 ips." This means that the magnetic tape recorder has 1% third-harmonic distortion of a 100-kHz signal at 60 ips.

## HARMONIC-DISTORTION DEFINITION

Harmonic distortion is *the production of harmonic frequencies by an electronic system when a signal is applied at the input*. When an input signal goes through nonlinear electronic circuitry, the output signal will include some harmonic distortion (or unwanted frequencies). If you analyzed this distortion, you'd see that a pattern exists. A pattern, whereby the frequency of each unwanted frequency is a multiple ( $\times 1$ ,  $\times 2$ ,  $\times 3$ , etc.) of the center frequency of the input signal.

There are two types of harmonic distortion: even-order and odd-order. If the frequencies of the distortion are 2, 4, 6, etc., times the center frequency, it's even-order harmonics. If the frequencies of the distortion are 3, 5, 7, etc., times the center frequency, it's odd-order harmonics.

Odd-order harmonics are normally caused by the magnetic tape itself. Even-order harmonics are normally caused by (1) permanently magnetized magnetic heads, (2) faulty circuits, or (3) asymmetrical or unbalanced bias signals. As you might guess, even-order harmonics can be reduced by doing the right maintenance and periodic performance tests.

The primary harmonic distortion in magnetic tape recorder systems is third-order harmonics. If the level of third-order harmonics in a recorder increases, the level of distortion will also increase (figures 6-4A and B show this relationship). Two things that determine the level of third-order harmonics in a recorder are (1) the signal bias level, and (2) the record level. Figure 6-4A shows how third-order harmonic distortion decreases as the signal bias level increases. Figure 6-4B shows how the third harmonic increases gradually at first and then abruptly as the record level increases. That's why the third harmonic is used to determine the normal record level.

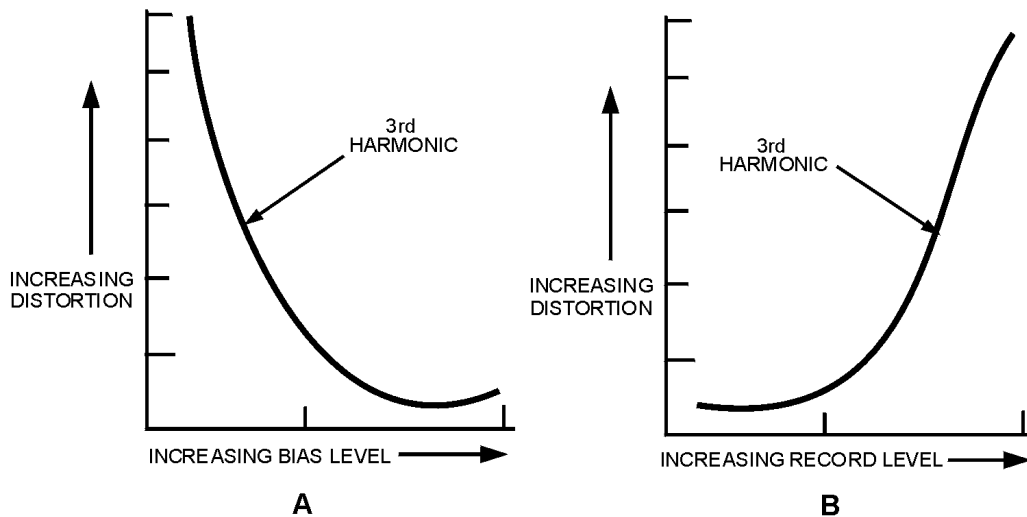

*Courtesy of DATATAPE Incorporated, Copyright © All rights reserved*

**Figure 6-4 A & B.—Effect of signal bias level and record level on harmonic-distortion level.**



## HARMONIC-DISTORTION MEASUREMENT

Figure 6-5 shows a typical test equipment setup for measuring harmonic distortion. With this setup, the test signal from the signal generator is recorded and reproduced by the magnetic tape recorder at a normal record level. The amount of harmonic distortion is measured at the recorder's output on the wave analyzer.

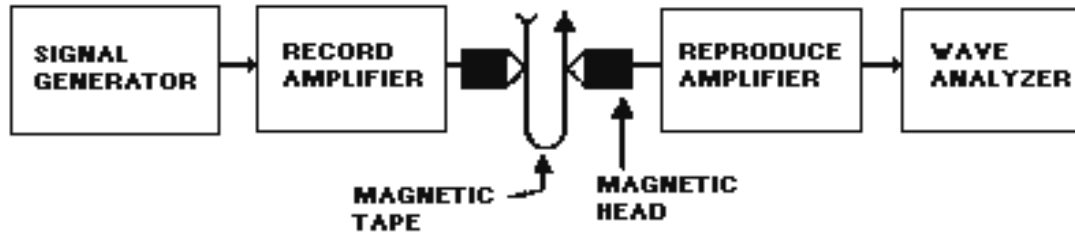

Figure 6-5.—Test equipment setup for measuring harmonic distortion.

The technical manual for the magnetic recorder you're testing will tell you how to set up the test equipment. It'll tell you to set up the wave analyzer to measure a specific frequency. This frequency will be one of the multiples ( $\times 1$ ,  $\times 2$ ,  $\times 3$ , etc.) of the frequency the signal generator is outputting.

For example, let's say the technical manual told you to set up the signal generator to input a 10-kHz test signal into the magnetic tape recorder. Since you want to measure third-order harmonics, the technical manual will tell you to set the wave analyzer to measure the amount of harmonic distortion at 30-kHz.

## PHASE RESPONSE

It used to be thought that the only important specifications of magnetic tape recorders were signal-to-noise ratio and frequency response. But now, with the need to record and reproduce more complex waveforms, such as telemetry and computer data, the phase-response specification becomes as important as frequency response.

### PHASE-RESPONSE DEFINITION

Phase response is *the expression of the variation of the phase shift with respect to frequency*. A good magnetic tape recorder will have linearly increasing phase response as frequency increases. In simpler terms, good phase response shows that a magnetic recorder can reproduce a complex waveform (such as a square wave which has an infinite number of sine waves) without distorting it. Figure 6-6 shows both good and bad phase response.

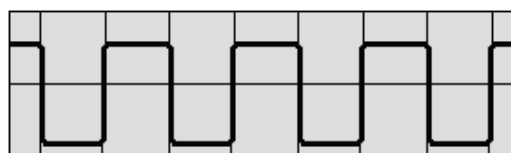

GOOD PHASE RESPONSE

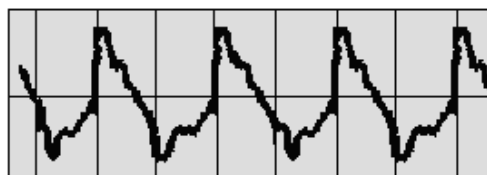

BAD PHASE RESPONSE

Figure 6-6.—Pictures showing the effect of good and bad phase response on square-wave reproduction.

### PHASE-RESPONSE MEASUREMENT

You cannot *directly* measure phase response. The best way to check the phase response of a magnetic tape recorder is to record and reproduce a square wave and watch the output on an oscilloscope. If the output signal is symmetrical, like in figure 6-7, the recorder has good phase response.

### LINEAR PHASE RESPONSE

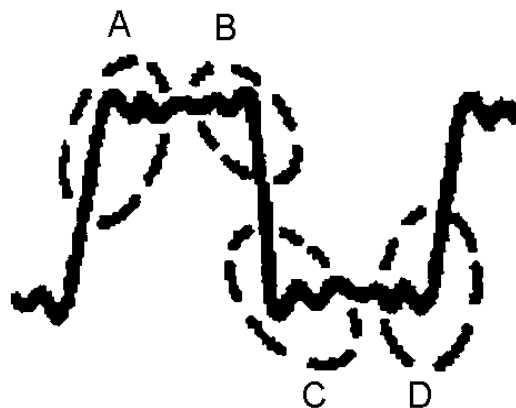

FOR LINEAR RESPONSE, A AND D,  
AND B AND C MUST BE SYMMETRICAL

Figure 6-7.—An example of good linear phase response.

Q-7. A recorder's harmonic-distortion specification reads 2% third harmonic of a 100-kHz signal at 60 ips. What does this mean?

Q-8. What are three possible causes of even-order harmonics?

Q-9. What number harmonic is the primary harmonic distortion in magnetic tape recorders?

Q-10. When measuring harmonic distortion, you set the signal generator to input a 15-kHz test signal. To what frequency should you set the wave analyzer?

Q-11. How should a tape recorder with good phase response reproduce a complex waveform, such as a square wave?

Q-12. How could you check the phase response of a tape recorder?

## FLUTTER

The general audio and broadcast field coined the term *flutter* to describe what you'll actually hear from the bad effects of this specification.

### FLUTTER DEFINITION

Flutter is *the result of non-uniform tape motion caused by variations in tape speed that produces frequency modulation of signals recorded onto magnetic tape.*

Flutter is usually expressed as a *percent peak* or a *peak-to-peak* value for instrumentation recorders and as a *root-mean-square (RMS)* value for audio recorders. It's caused by magnetic tape transports. Low-frequency flutter (below 1000 Hz) is caused by the rotating parts of a tape transport such as:

- Irregular magnetic tape supply or take-up reels.
- Uneven or sticking guide rollers and pinch rollers.
- Capstans.

High-frequency flutter (above 1000 Hz) is caused by the *fixed* parts of a tape transport, such as fixed tape guides and magnetic heads. When the magnetic tape passes over a fixed tape guide or magnetic head, the transition from static to dynamic friction causes something called *stiction*. It's this stiction that causes the variations in tape speed which, in turn, cause the flutter.

As you might guess, it's hard to prevent flutter. The only way to lessen flutter is through skilled engineering, machining, and design of magnetic tape recorders.

### FLUTTER MEASUREMENT

There are many ways to measure flutter. Most are based on the fact that tape speed variations cause frequency modulation of a recorded tone. Figure 6-8 shows a typical setup for measuring the peak-to-peak value of flutter with a frequency-modulation (FM) demodulator and an oscilloscope. The technical manual for the magnetic tape recorder you're testing will tell you how to set up the signal generator to output the test signal. After setting up the test equipment, follow these procedures:

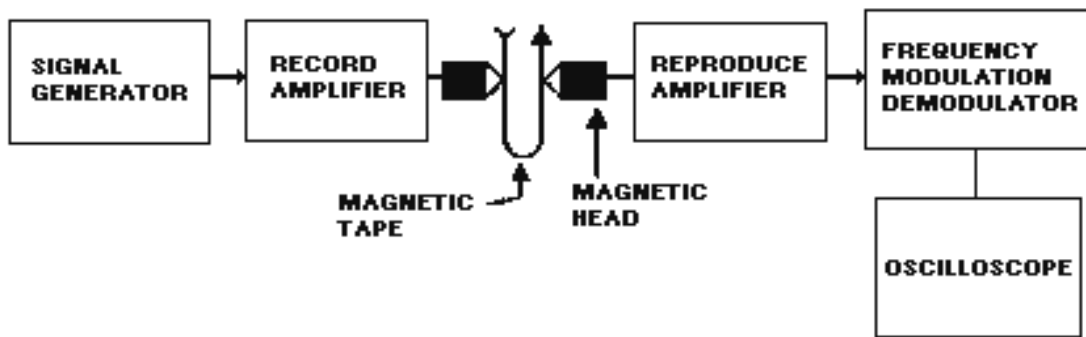

Figure 6-8.—Test equipment setup for measuring flutter.

1. Record the test signal onto magnetic tape; then rewind the magnetic tape. This is necessary because you can't measure flutter as you're recording. Since the tape-speed variation past the record head is almost the same as past the reproduce head, the flutter level is too small to see.
2. After you rewind the tape, play it back. During playback, the output signal from the tape recorder goes through the FM demodulator to remove the original test signal. The waveform you now see on the oscilloscope is the actual flutter signal that was modulated onto the test signal.
3. Using the oscilloscope display, measure the peak-to-peak value of the flutter signal.

## TIME-BASE ERROR

The time-base error (TBE) specification of magnetic tape recorders is closely related to the flutter specification. In fact, the TBE is a direct measure of the effects of flutter on the stability of recorded data.

### TIME-BASE ERROR DEFINITION

The TBE is *the time-relationship error between two or more events recorded and reproduced from the same magnetic tape*. It's also defined as *the displacement of a point on the magnetic tape from where it should have been, during a specific time interval*.

A typical TBE specification might read "+ / - 100 microseconds over a 10-millisecond time interval at a tape speed of 60 inches per second, referenced to a control tone." This means that the time-base error could cause a signal to *jitter* +/- 100 microseconds over a 10-millisecond period at a tape speed of 60 inches per second.

TBE jitter introduces noise or unwanted frequency modulation (when using FM recording techniques) into the magnetic tape recording process. It can also cause a loss of accuracy in pulse-duration modulation (PDM), pulse-coded modulation (PCM), or other magnetic recordings where precise timing relationships exist between two or more signals.

### TIME-BASE ERROR MEASUREMENT

The simplest way to measure the TBE is with an oscilloscope. Figure 6-9 shows a typical test equipment setup for measuring TBE. After you set up the test equipment, measure the TBE as follows:

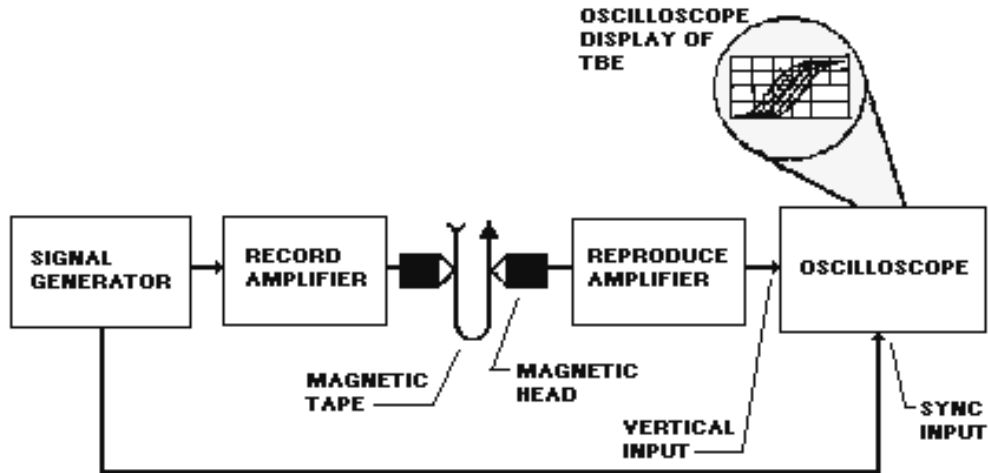

Figure 6-9.—Test equipment setup for measuring time-base error.

1. Set the signal generator to generate a test signal. The technical manual for the magnetic tape recorder you're testing will tell you how.
2. Connect the test signal output from the signal generator to both the recorder's input and the oscilloscope's trigger (sync) input.
3. Connect the output of the tape recorder to the oscilloscope's signal (vertical) input.
4. Record and reproduce the test signal.
5. Adjust the oscilloscope's intensity control until you can see the TBE on the oscilloscope's display. (Limit glare by using a hood on the oscilloscope's display.)

## SKEW

This magnetic tape recording specification only applies to multi-tracked magnetic tape recorders.

### SKEW DEFINITION

Skew is *the inter-track fixed and dynamic displacement, or change in azimuth, encountered by different tracks across the width of the magnetic tape as it passes the magnetic heads*. In other words, it's the time difference between the tracks on a multi-tracked magnetic head.

A typical skew specification might read "+/- 0.15 microseconds between adjacent tracks on the same head stack at 120 inches per second." This means that one of the tracks on a magnetic head could lead, or lag, the track next to it by as much as 0.15 microseconds at 120 ips. This specification applies to both fixed and dynamic skew.

Fixed skew can be caused by

- magnetic tape recorder electronics,

- gap scatter in the magnetic head stack,
- azimuth alignment of the magnetic head stack, or
- fixed difference in tension along the tape path

You can minimize most fixed skew by adjusting the magnetic recorder's electronics or by realigning the magnetic heads.

Fixed skew errors usually do not show up when magnetic tapes are recorded and reproduced on the same tape recorder. Since fixed skew errors are additive, they'll usually show up when you record on one magnetic tape recorder and then reproduce on another.

Dynamic skew errors are caused by either the magnetic tape transport or the magnetic tape itself. If the tape transport guides are worn or sticking, the magnetic tape won't properly pass over the magnetic heads. It'll *drift* and pass the magnetic head at an angle (like a car skidding on an icy road). If the magnetic tape itself is warped or isn't uniform across its width it, too, will cause dynamic skew.

### SKEW MEASUREMENT

Skew is best measured with an oscilloscope. Figure 6-10 shows a typical test equipment setup for measuring skew. The technical manual for the magnetic tape recorder you're testing will tell you how to set up the signal generator. After test equipment setup, measure the skew as follows:

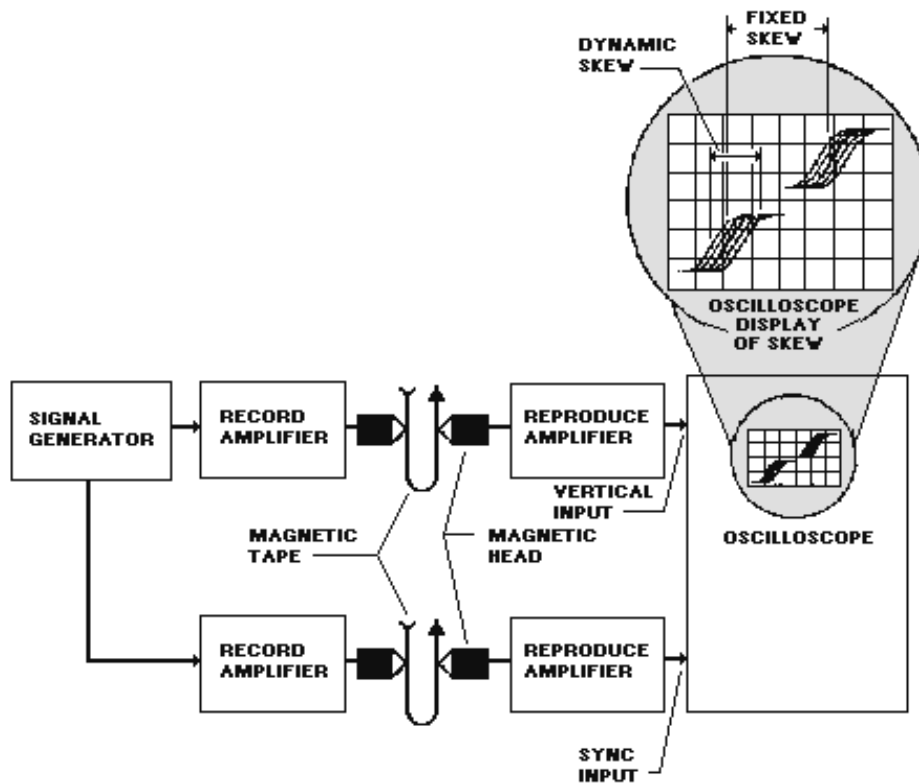

Figure 6-10.—Test equipment setup for measuring skew.

1. Inject the test signal into a reference track and one other track of the multi-track magnetic tape recorder. (The reference track should be one of the two *outside* tracks of the magnetic head.)
2. Connect the output from the reference track to the *sync* input of the oscilloscope to trigger the horizontal sweep.
3. Connect the output from the other track to the *vertical* input of the oscilloscope.
4. While recording and reproducing the test signal, measure the fixed and dynamic skews which are displayed on the oscilloscope. Figure 6-10 shows how this looks.

Q-13. *What causes flutter in a tape recorder's output?*

Q-14. *What causes low-frequency flutter (below 1000 Hz)?*

Q-15. *What causes high-frequency flutter (above 1000 Hz)?*

Q-16. *Your recorder's TBE specification reads "  $\pm 80$  microseconds over a 10 millisecond time interval at a tape speed of 60 ips, referenced to a control tone." What does this mean?*

Q-17. *Why is it important to minimize TBE jitter in magnetic tape recordings where precise timing relationships exist between two or more signals?*

Q-18. *The skew specification of your multi-tracked tape recorder reads "  $\pm 0.20$  microseconds between adjacent tracks on the same head stack at 120 ips." What does this mean?*

Q-19. *How can you minimize fixed skew?*

Q-20. *When are fixed skew errors most likely to show up?*

Q-21. *How do worn or sticking tape transport guides cause dynamic skew on a multi-track recorder?*

## SUMMARY

Now that you've finished chapter 6, you should be able to describe the seven most common magnetic tape recording specifications and how to measure each specification. The following is a summary of important points in this chapter:

The **SIGNAL-TO-NOISE RATIO (SNR)** is the ratio of the normal signal level to the tape recorder's own noise level measured in dB. The higher a recorder's SNR, the wider the range of signals it can record and reproduce.

**SNR IS STATED IN ONE OF THREE WAYS** based on how it was measured. If you don't know the way it was measured, you could be misled.

A recorder's **FREQUENCY-RESPONSE** specification is sometimes called its *bandwidth*. It tells the range of frequencies a recorder can effectively record and reproduce. Factors that can degrade a recorder's frequency response are an improper *bias level setting*, *reproduce head gap*, or *tape transport speed*. Also, failure to clean the heads and the tape transport can cause poor *tape-to-head contact*.

**HARMONIC DISTORTION** is the production of unwanted harmonic frequencies when a signal is applied at the recorder's input. The primary harmonic distortion in tape recorders is third order harmonics. It's measured with a wave analyzer. You can reduce this distortion with proper preventive maintenance and periodic performance tests.

Good **PHASE RESPONSE** means the recorder can reproduce complex waveforms such as square waves without distortion. The best way to check a recorder's phase response is by recording and reproducing a square wave and checking the output on an oscilloscope.

**FLUTTER** results from non-uniform tape motion caused by variations in tape speed. The tape speed variations are caused by design and machining deficiencies in the rotating and fixed parts of the tape transport.

**TIME-BASE ERROR (TBE)** is the time-relationship error between two or more events recorded on and reproduced from the same magnetic tape. It causes TBE jitter, which introduces noise or loss of accuracy where precise timing relationships exist between two or more signals.

**SKREW** is the time difference in microseconds between the tracks on a multi-tracked tape recorder. *Fixed* or *dynamic* skew can happen when one of the tracks on the multi-track head leads or lags the track next to it. *Fixed skew* errors only show up when you record on one recorder and reproduce on a different recorder. You can minimize fixed skew by adjusting the recorder's electronics and aligning the heads. *Dynamic skew* errors are caused by worn or sticking tape transport guides or by warped magnetic tape.

#### **ANSWERS TO QUESTIONS Q1. THROUGH Q21.**

- A1. *35-dB RMS because the highest SNR can always record and reproduce the widest range of input signals.*
- A2. *A VTVM and a signal generator. (See figure 6-1.)*
- A3.
- a. *Root-mean-square (RMS) signal-to-RMS noise.*
  - b. *Peak-to-peak signal-to-RMS noise.*
  - c. *Peak signal-to-RMS noise.*
- A4. *The recorder can record all frequencies between 150 Hz and 150 kHz at 60 ips without varying the output amplitude more than 3 dB.*
- A5. *The upper and lower limits of the frequency response specification for that tape recorder.*
- A6.
- a. *A too-high or too-low bias signal level setting for the record head.*
  - b. *An improper reproduce head gap.*
  - c. *An improper tape transport speed.*
  - d. *Poor tape-to-head contact.*



- A7. *The recorder has 2% third-harmonic distortion of a 100-kHz signal at 60 ips.*
- A8.
- a. *Permanently magnetized heads.*
  - b. *Faulty circuitry.*
  - c. *Asymmetrical bias signal.*
- A9. *Third-order harmonic.*
- A10. *45 kHz.*
- A11. *With no distortion.*
- A12. *Record and reproduce a square wave and see if the output on an oscilloscope is symmetrical.*
- A13. *Non-uniform tape motion caused by variations in tape speed.*
- A14. *Rotating parts of a tape transport, such as irregular tape reels, sticking guides and pinch rollers, and capstans.*
- A15. *Fixed parts of a tape transport, such as fixed tape guides and magnetic heads.*
- A16. *The TBE could cause a signal to jitter  $\pm 80$  microseconds over a 10-millisecond period at a tape speed of 60 ips.*
- A17. *The jitter could cause noise and a loss of accuracy.*
- A18. *One of the tracks on a magnetic head could lead or lag the track next to it by as much as 0.20 microseconds at 120 ips.*
- A19. *Adjust the recorder's electronics or realign the magnetic heads.*
- A20. *When you record on one tape recorder and then reproduce on a different recorder.*
- A21. *The tape drifts past the multi-track head at an angle.*



# CHAPTER 7

## DIGITAL MAGNETIC TAPE RECORDING

### LEARNING OBJECTIVES

After completing this chapter, you'll be able to do the following:

1. Describe the characteristics of digital magnetic tape recording and the difference between *analog* and *digital* recording.
2. Describe each of the three *formats* for digital magnetic tape recording (serial, parallel, and serial-parallel).
3. Define the following terms as they apply to digital magnetic tape recording: *mark*, *space*, *bit-cell period*, *packing density*, and *bit-error rate (BER)*.
4. Describe the eight most common methods for encoding digital data onto magnetic tape.
5. Describe the characteristics and use of the following categories of digital magnetic tape recorders: (1) computer-compatible, (2) telemetry, and (3) instrumentation.

### INTRODUCTION TO DIGITAL MAGNETIC TAPE RECORDING

This chapter introduces you to digital magnetic tape recording. It describes (1) the three formats for digital magnetic tape recording, (2) the eight methods of encoding digital data onto magnetic tape, and (3) the configuration differences between the three types of digital tape recorders.

Until now, you've learned about magnetic tape recording from an *analog* point-of-view. That is, the signal you record and reproduce is the actual analog input signal waveform. In digital magnetic tape recording, the signal you record and reproduce is, instead, a series of *digital* pulses. These pulses are called binary *ones* and *zeros*. These *ones* and *zeros* can represent one of three types of data: (1) data used by digital computers, (2) pulsed square-wave signals, or (3) digitized analog waveforms.

The digital magnetic tape recording process stores data onto tape by magnetizing the tape to its saturation point in one of two possible polarities: positive (+) or negative (–). The *saturation* point of magnetic tape is the point where the magnetic tape is magnetized as much as it can be.

### DIGITAL MAGNETIC TAPE RECORDING FORMATS

There are three digital magnetic tape recording formats: *serial*, *parallel*, and *serial-parallel*. Each of these is described below. Figure 7-1 shows each of the three formats as they apply to recording an eight-bit binary data stream.

## SERIAL DIGITAL MAGNETIC TAPE RECORDING FORMAT

This is the simplest of the three digital magnetic tape recording formats. It's usually used when recording instrumentation or telemetry data. In this format, the incoming data pulses are recorded onto a single recorder track of the magnetic tape in a single, continuous stream. Figure 7-1A shows how this looks.

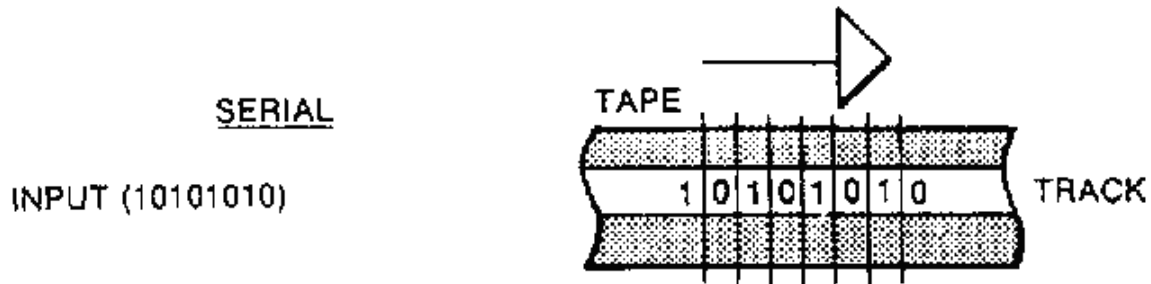

*Courtesy of DATATAPE Incorporated, Copyright © All rights reserved*

Figure 7-1A.—Digital magnetic tape recording formats.

## PARALLEL DIGITAL MAGNETIC TAPE RECORDING FORMAT

In this format, the incoming data pulses come in on more than one input channel and are recorded *side-by-side* onto more than one tape track. The data pulses across the width of the magnetic tape are *related* to each other. Figure 7-1B shows how this looks. This format is usually used to store computer data.

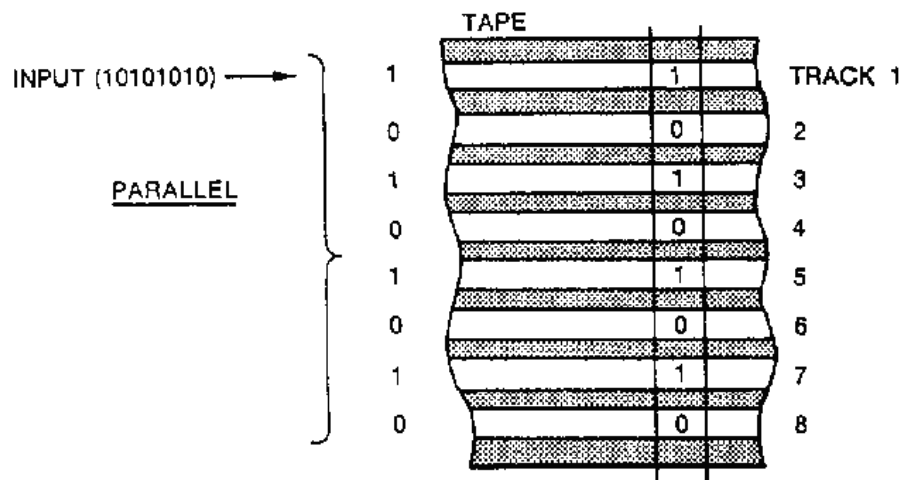

*Courtesy of DATATAPE Incorporated, Copyright © All rights reserved*

Figure 7-1B.—Digital magnetic tape recording formats.

## SERIAL-PARALLEL DIGITAL MAGNETIC TAPE RECORDING FORMAT

This format is more complex. It takes a serial input stream of data pulses, breaks them up, and records them on more than one recorder track. When the tape is reproduced, the recorder recombines the broken-apart data into its original form. Figure 7-1C shows how this looks. The serial-parallel format is usually used in instrumentation recording when the input data rate is high.

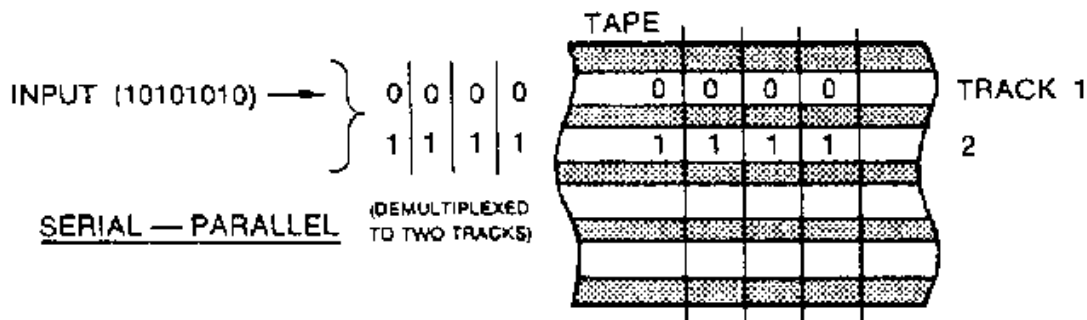

*Courtesy of DATATAPE Incorporated, Copyright © All rights reserved*

Figure 7-1C.—Digital magnetic tape recording formats.

## DIGITAL MAGNETIC TAPE RECORDING DEFINITIONS

Before we describe the methods for encoding digital data onto magnetic tape, let's define the following terms:

**Mark:** The voltage state of a digital *one* (1) data bit. It's also sometimes called *true*.

**Space:** The voltage state of a digital *zero* (0) data bit. It's also sometimes called *false*.

**Bit-cell period:** The time occupied by a single digital bit.

**Packing density:** The number of bits per fixed length of magnetic tape per track. There are three categories of packing density:

1. Low density—200 to 1,000 bits per inch (bpi).
2. Medium density—1,000 to 8,000 bpi.
3. High density—8,000 to 33,000 bpi.

**Bit-error rate:** The number of bits within a finite series of bits that will be reproduced incorrectly.

*Q-1. In digital magnetic tape recording, the series of recorded digital pulses can represent what three types of data?*

*Q-2. What three formats are used for digital magnetic tape recording?*

*Q-3. What format of digital tape recording is normally used to store computer data?*

- Q-4. What format of digital tape recording takes a serial input stream of data pulses, breaks them up, and records them on more than one data track?
- Q-5. What format of digital tape recording is normally used to record instrumentation or telemetry data?

### DIGITAL MAGNETIC TAPE RECORDING ENCODING METHODS

This section describes how digital data is *electrically* encoded onto the magnetic tape. The following paragraphs describe the eight most common digital data encoding methods.

1. Return to bias (RB)
2. Return to zero (RZ)
3. Non-return to zero (NRZ) and these four variations of the NRZ method:
  - a. Non-return-to-zero level (NRZ-L)
  - b. Enhanced non-return-to-zero level (E-NRZ-L)
  - c. Non-return-to-zero mark (NRZ-M)
  - d. Non-return-to-zero space (NRZ-S)
4. Bi-phase level

#### RETURN-TO-BIAS (RB) ENCODING

The RB encoding method uses magnetic tape that is *pre-set* to one of the two polarities (+ or -). This pre-sets the magnetic tape to *all zeros*. Digital *ones* are then recorded onto the magnetic tape by magnetizing the tape in the opposite polarity. After each *one* pulse, the tape returns to its original bias condition. Figure 7-2 shows the magnetic tape *pre-set* to a negative bias condition. It also shows how the digital data word 0100110001 is stored onto the magnetic tape using the RB encoding method.

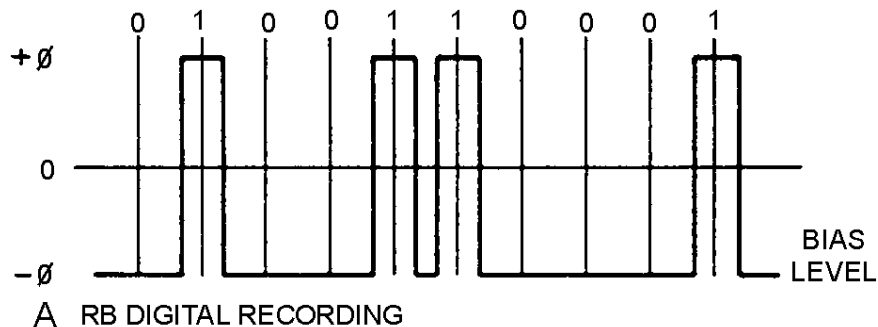

Figure 7-2.—Return-to-bias (RB) digital encoding method.

This method has a serious drawback: It requires an external clocking signal to read the zeros stored on the tape.

## RETURN-TO-ZERO (RZ) ENCODING

The RZ encoding method uses magnetic tape that is normally in a *neutral* condition (the tape is not biased positively or negatively). A digital *one* is recorded as a positive-going pulse: a digital *zero* is recorded as a negative-going pulse. The magnetic tape returns to its *neutral* state in between pulses. Figure 7-3 shows the magnetic tape in its neutral state. It also shows how the digital data word 0100110001 is stored onto the magnetic tape using return-to-zero encoding.

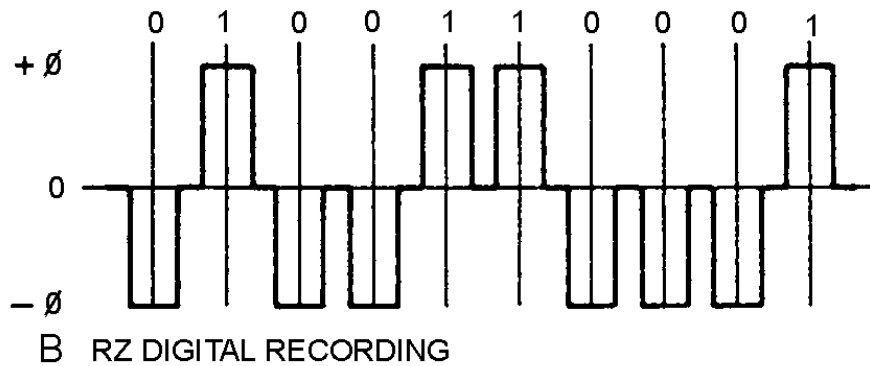
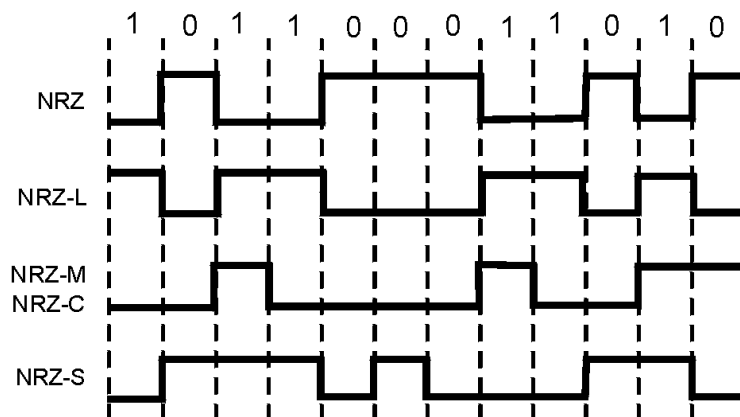

Figure 7-3.—Return-to-zero (RZ) digital encoding method.

## NON-RETURN-TO-ZERO (NRZ) ENCODING

The NRZ encoding method is, by far, the most widely used. It's accurate, simple, and reliable. It does not return the magnetic tape to its *neutral* state in between pulses. The magnetic tape is always in saturation, either positively or negatively. The polarity of the saturating signal only changes when incoming data changes from a *zero* to a *one* and vice versa. Figure 7-4 shows how the digital data word 101100011010 is stored onto the magnetic tape using the NRZ encoding method.



Courtesy of DATATAPE Incorporated, Copyright © All rights reserved

Figure 7-4.—Non-return-to-zero (NRZ) digital encoding method.

There are four widely used variations to the basic NRZ encoding method. Each of these is described in the following paragraphs.

### Non-Return-To-Zero-Level (NRZ-L) Encoding

In NRZ-L encoding, the polarity of the saturating signal changes only when the incoming signal changes from a *one* to a *zero* or from a *zero* to a *one*. Figure 7-4 also shows how the digital data word 101100011010 is stored onto the magnetic tape using the NRZ-L encoding method. Note that the NRZ-L method looks just like the NRZ method, except for the first input *one* data bit. This is because NRZ does not consider the first data bit to be a polarity change, where NRZ-L does.

The NRZ-L encoding method isn't normally used in higher density (over 20,000 bpi) digital magnetic recording. This encoding method is sometimes called the non-return-to-zero-change (NRZ-C) encoding method.

### Enhanced Non-Return-to-Zero-Level (E-NRZ-L) Encoding

This encoding method takes the basic NRZ-L data and adds a parity bit to it after every seven incoming data bits. The polarity of the parity bit is such that the total number of *ones* in the eight-bit data word will be an *odd* count. Figure 7-5 shows how the digital data word 0100010 is stored onto the magnetic tape using the E-NRZ-L encoding method.

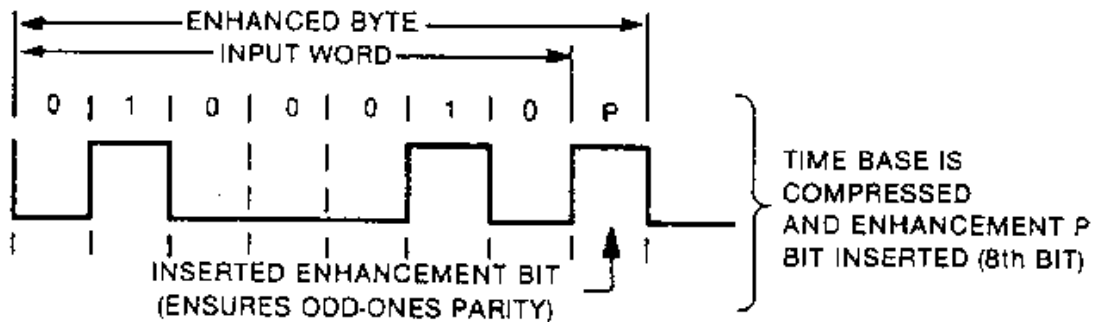

*Courtesy of DATATAPE Incorporated, Copyright © All rights reserved*

Figure 7-5.—Enhanced non-return-to-zero-level (E-NRZ-L) digital encoding method.

Before the parity bit is added, the original incoming data is compressed in time. This is done so that when the parity bit is added, the eight-bit data word takes up the same amount of time as the original-seven bit data word. When the tape is reproduced, the parity bit is taken out.

This encoding method works very well in high density (up to 33,000 bpi) magnetic tape recording. And, it offers an extremely good bit-error rate of 1 error per 1 million bits.

### Non-Return-to-Zero-Mark (NRZ-M) Encoding

The NRZ-M encoding method is probably the most widely used encoding method for 800-bpi digital magnetic tape recording. In this method, the polarity of the saturating signal changes when the incoming signal is a *one*. An incoming *zero* would not change the polarity of the saturating signal.

NRZ-M offers better protection from error than straight NRZ. In NRZ-M, there's a one-to-one relationship between incoming data and polarity changes. If one data bit is lost, only that one bit is lost.



Whereas, in straight NRZ, if one bit is lost, all of the bits that follow will be exactly the opposite in polarity from what they should be. Figure 7-4 also shows how the digital data word 101100011010 is stored onto the magnetic tape using the NRZ-M encoding method.

### Non-Return-to-Zero-Space (NRZ-S) Encoding

The NRZ-S encoding method works just like NRZ-M encoding, with one exception. Instead of the saturating signal changing polarity when the incoming data signal is a *one*, it changes when the incoming data signal is a *zero*.

### BI-PHASE LEVEL ENCODING

The bi-phase level encoding method records two logic levels for each incoming data bit. When an incoming data bit is a *one*, bi-phase level recording records a *zero-one*. When an incoming data bit is a *zero*, bi-phase level recording records a *one-zero*. This encoding method helps to overcome any low-frequency response problems that the magnetic tape recorder may have. Figure 7-6 shows how the digital data word 101000111001 is stored onto magnetic tape using the bi-phase encoding method.

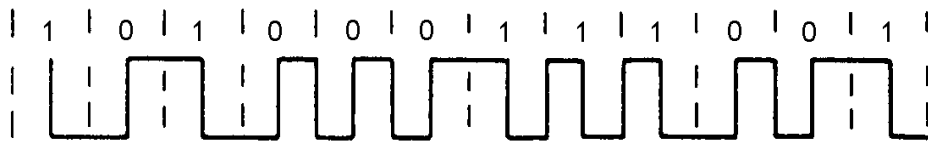

*Courtesy of DATATAPE Incorporated, Copyright © All rights reserved*

**Figure 7-6.—Bi-phase level digital encoding method.**

Bi-phase encoding requires exactly twice the bandwidth of NRZ-L. That's why it's mostly used in medium-density digital magnetic tape recording. In fact, this encoding method is probably the most widely used encoding method for 1600-bpi digital magnetic tape recording.

## DIGITAL MAGNETIC TAPE RECORDER USES

As you already know, digital magnetic tape recorders are used to store and retrieve *digital* data. These recorders fall into one of three categories, (1) computer compatible, (2) telemetry, and (3) instrumentation.

### COMPUTER-COMPATIBLE DIGITAL TAPE RECORDERS

Computer-compatible digital tape recorders store and retrieve computer programs and data. They're usually multi-tracked tape recorders with at least two, and up to nine, tracks for data. They use either 1/4" or 1/2" magnetic tape on either reels or cartridges.

### TELEMETRY DIGITAL TAPE RECORDERS

Telemetry digital magnetic tape recorders are more commonly called *wideband* recorders. They're used for recording radar signals and other pulsed square-wave type signals with a bandwidth of 500 kHz to 2 MHz. They're also multi-tracked tape recorders that have either 14 or 28 tracks for data. They use 1" magnetic tape on either aluminum or glass reels.

## INSTRUMENTATION MAGNETIC TAPE RECORDERS

Instrumentation digital magnetic tape recorders are used to record other special signals with a bandwidth of less than 500 kHz. They, too, are multi-tracked recorders, normally with 7 tracks for data. They use 1/2" magnetic tape on metal or glass reels.

- Q-6. Which of the eight methods for encoding digital data onto magnetic tape is most widely used because it's accurate, simple, and reliable?
- Q-7. Which digital data tape encoding method presets the magnetic tape to all zeros and then records digital ones onto the tape?
- Q-8. Which digital data encoding method records a digital one as a positive pulse and a digital (zero) as a negative pulse and returns the tape to neutral between pulses?
- Q-9. Which method of digital data encoding does NOT return the tape to neutral between pulses but, instead, saturates the tape positively or negatively as the incoming data changes between zero and one?
- Q-10. What are the four widely used variations of the NRZ encoding method?
- Q-11. Which digital data encoding method helps overcome a tape recorder's low-frequency response problems by recording two logic levels for each incoming data bit?
- Q-12. Digital magnetic tape recorders used to store and retrieve digital data fall into what three categories?
- Q-13. What category of digital tape recorder is used for recording pulsed square-wave signals with a bandwidth of 500 kHz to 2 MHz?
- Q-14. What category of digital tape recorder is used to record special signals with a bandwidth of less than 500 kHz?

## SUMMARY

Now that you've finished chapter 7, you should be able to describe (1) the characteristics of digital magnetic tape recording, (2) the three *formats* for digital magnetic tape recording, (3) the eight *methods* for encoding digital data onto magnetic tape, and (4) the characteristics and uses of the three types of digital magnetic tape recorders. The following is a summary of important points in this chapter:

Digital magnetic tape recorders record a **SERIES OF DIGITAL PULSES** called binary *ones* and *zeros*. These digital pulses can represent (1) data used by digital computers, (2) pulsed square-wave signals, or (3) digitized analog waveforms.

Three **FORMATS FOR DIGITAL MAGNETIC TAPE RECORDING** are *serial*, *parallel*, and *serial-parallel*.

There are **EIGHT COMMONLY USED METHODS FOR ENCODING** digital data onto magnetic tape. The non-return-to-zero (NRZ) method and the four variations of the NRZ method are most commonly used.

**THREE CATEGORIES OF DIGITAL MAGNETIC TAPE RECORDERS** are (1) computer-compatible, (2) telemetry, and (3) instrumentation.

**ANSWERS TO QUESTIONS Q1. THROUGH Q14.**

A1.

- a. *Data used by digital computers.*
- b. *Pulsed squarewave signals.*
- c. *Digitized analog waveforms.*

A2. *(1) Serial, (2) parallel, and (3) serial-parallel.*

A3. *Parallel digital magnetic tape recording.*

A4. *Serial-parallel digital magnetic tape recording.*

A5. *Serial digital magnetic tape recording.*

A6. *Non-return-to-zero (NRZ) encoding.*

A7. *Return-to-bias (RB) encoding.*

A8. *Return-to-zero (RZ) encoding.*

A9. *Non-return-to-zero (NRZ) encoding.*

A10.

- a. *Non-return-to-zero level (NRZ-L).*
- b. *Enhanced non-return-to-zero level (E-NRZ-L).*
- c. *Non-return-to-zero mark (NRZ-M).*
- d. *Non-return-to-zero space (NRZ-S).*

A11. *Bi-phase level encoding.*

A12.

- a. *Computer-compatible digital tape recorders.*
- b. *Telemetry digital tape recorders.*
- c. *Instrumentation digital tape recorders.*

A13. *Telemetry digital tape recorders.*

A14. *Instrumentation digital tape recorders.*



# CHAPTER 8

## MAGNETIC DISK RECORDING

### LEARNING OBJECTIVES

After completing this chapter, you'll be able to do the following:

1. Describe how flexible (floppy) disks are constructed; how data is organized on them; how they are handled, stored, and shipped; and how they are erased.
2. Describe how fixed (hard) disks are constructed; how data is organized on them; how they are handled, stored, and shipped; and how they are erased.
3. Describe each of the following methods for recording (encoding) digital data onto magnetic disks: *frequency-modulation* encoding, *modified frequency-modulation* encoding, and *run length-limited* encoding.
4. Describe the characteristics of *floppy disk drive transports* and *hard disk drive transports* and describe the preventive maintenance requirements of each type.
5. Describe the following parts of the *electronics* component of a magnetic disk drive: control electronics, *write/read* electronics, and *interface* electronics.
6. Describe the five most common types of disk drive interface electronics.
7. Define the following magnetic disk recording *specifications*: seek time, latency period, access time, interleave factor, transfer rate, and recording density.

### INTRODUCTION

Magnetic disk recording was invented by International Business Machines (IBM) in 1956. It was developed to allow mainframe computers to store large amounts of computer programs and data. This new technology eventually led to what's now known as the computer revolution.

This chapter introduces you to the following aspects of magnetic disk recording:

- Disk recording mediums
- Disk recording methods
- Disk drive transports
- Disk drive electronics
- Disk recording specifications

## MAGNETIC DISK RECORDING MEDIUMS

There are two types of disk recording mediums: *flexible diskettes* and *fixed (hard) disks*. The following paragraphs describe (1) how flexible and fixed disks are made; (2) how data is organized on them; (3) how to handle, store, and ship them; (4) and how to erase them.

### FLEXIBLE MAGNETIC RECORDING DISKETTES

Flexible diskettes, or *floppy disks* as they're more commonly called, are inexpensive, flexible, and portable magnetic storage mediums. They have the following characteristics.

#### Floppy Disk Construction

Floppy disks are made of round plastic disks coated with magnetic oxide particles. The disks are enclosed in a plastic jacket which protects the magnetic recording surface from damage.

Floppy disks come in three sizes: 8 inch, 5 1/4 inch, and 3 1/2 inch. Figure 8-1 shows each size. All disk sizes can either be *single-sided* or *double-sided*. Single-sided disks store data on only one side of the disk; double-sided disks store data on both sides.

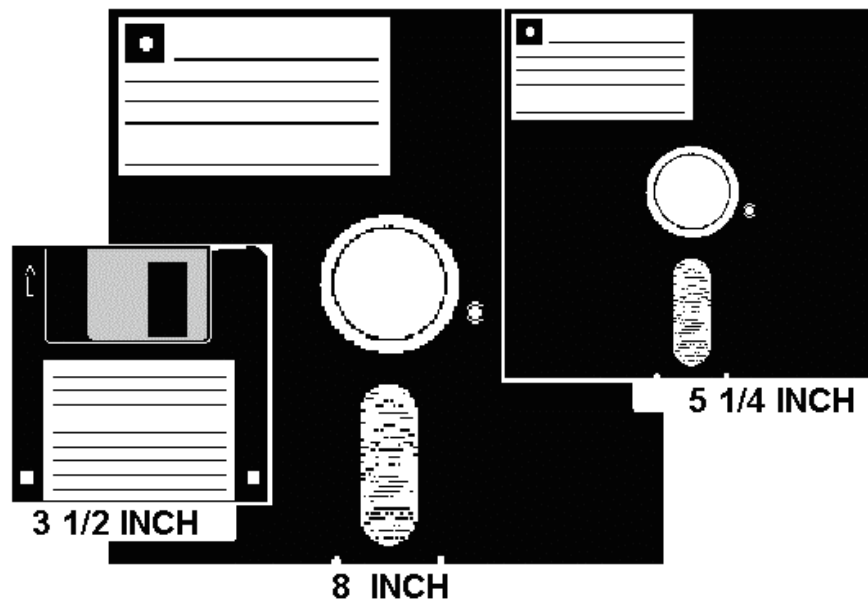

Figure 8-1.—Floppy disk construction.

When floppy disks are manufactured, the magnetic oxide coating is applied to both sides. Each disk is then checked for errors. Disks certified as single-sided, are checked on only one side; disks certified as double-sided are checked on both sides.

Floppy disks are also classified by how much data they can store. This is called a disk's *density*. There are three levels of floppy disk density: *single-density*, *double-density*, and *high-density*.

Some of the more common types of floppy disks and their storage capacity are listed below:

TYPE OF FLOPPY DISK	STORAGE CAPACITY
5-1/4" double-sided, double-density	360,000 bytes
5-1/4" double-sided, high-density	1,200,000 bytes
3-1/2" double-sided, double-density	720,000 bytes
3-1/2" double-sided, high-density	1,400,000 bytes

### Floppy Disk Data Organization

Data is stored on a floppy disk in circular *tracks*. Figure 8-2 shows a circular track on a floppy disk. The total number of tracks on a floppy disk is permanently set by (1) the number of steps the disk drive's magnetic head stepper motor can make, and (2) whether the disk drive has a magnetic head for one or both surfaces of the floppy disk. These two things will also determine the type of floppy disk that's needed. Each type of disk is rated with a number that represents how many *tracks per inch (TPI)* it can hold. Some common track capacities are 40, 48, 80, and 96 TPI.

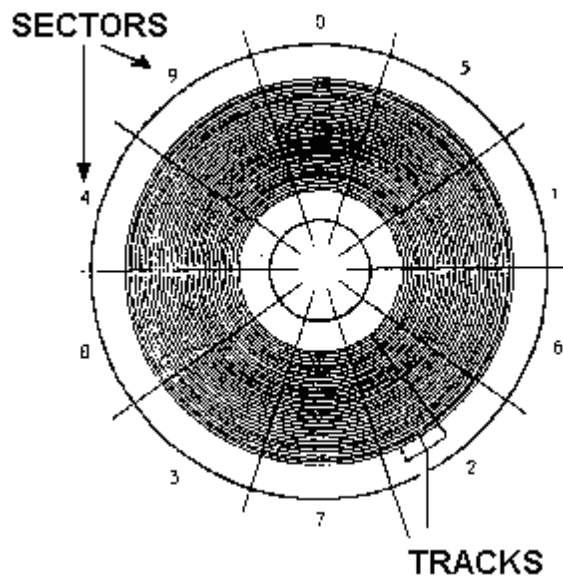

Figure 8-2.—Tracks and sectors of a magnetic disk.

Each track of a floppy disk is broken up into arcs called *sectors*. A disk is sectored just as you'd slice an apple pie. Figure 8-2 shows the sectors of a floppy disk. How many slices are made? That depends on who made the disk and in what host computer the disk is used.

There are two methods for *sectoring* a floppy disk:

1. **Hard Sectoring:** This method sectors the disk *physically*. The disk itself will have marks or sensor holes on it that the floppy disk drive hardware can detect. This method is seldom used today.
2. **Soft sectoring:** This method sectors the disk *logically*. The computer software determines the sector size and placement, and then *slices* the disk into sectors by writing codes on the disk. This

is called *formatting* or *initializing* a floppy disk. During formatting, if the computer software locates a bad spot on the disk, it locks it out to prevent the bad spot from being used. Soft sectoring is by far the most popular method of sectoring a floppy disk.

Once a floppy disk is *formatted*, the computer uses the disk's side number, a track number, and a sector number (together) as an *address*. It's this address that locates where on the disk the computer will store the data.

### Floppy Disk Handling, Storage, and Shipping

Floppy disks hold a lot of data. Even disks with only a 360,000-byte storage capacity can hold 180 pages of data! That's why it's important to handle, store, and ship floppy disks properly. One hundred and eighty pages of data is a lot of data to retype just because of carelessness.

Before we get into disk handling and storage procedures, let's first learn about head-to-disk contact. Do you remember reading in chapter 2 that the quality of magnetic tape recording is seriously degraded when dust, dirt, or other contaminants get between the magnetic head and the tape? Well, the same is true for magnetic disk recording. In fact, head-to-disk contact is extremely important with floppy disks. This is because floppy disk drives, unlike magnetic tape drives, spin at very high speeds — 300 to 600 revolutions-per-minute (RPM). If anything gets between the head and the recording surface, you can lose data, or even worse, you can damage the magnetic head and the disk's recording surface. Figure 8-3 shows the size relationship between a disk drive's magnetic head, the disk recording surface, and some common contaminants.

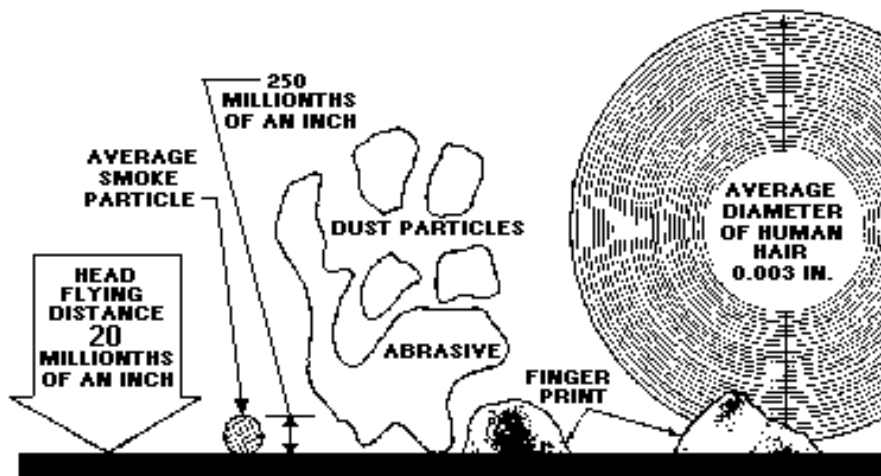

Figure 8-3.—Size relationship of distance between head and disk to contaminants.

You must handle, store, and ship floppy disks with great care if you want them to stay in good condition. Here's some specific precautions you should take:

- DO always store 8" and 5-1/4" floppy disks in their envelopes when not in use. Dirt, dust, etc., can get on the recording surface through the magnetic head read/write access hole if you leave it exposed for any length of time.



- DO always write on a floppy disk label first, and then place the label on the disk. NEVER write directly on a floppy disk. If you absolutely must write on a disk, use a felt-tip marker.
- DO hold floppy disks by their outside corners only. DO NOT bend them. And NEVER, NEVER paper clip them to anything, or anything to them.
- DO always store floppy disks in an upright position. Laying them on their side can cause them to warp.
- DO always keep floppy disks away from food, liquids, and cigarette smoke. All of these can easily damage floppy disks.
- DO always ship floppy disks in appropriate shipping containers. When shipping only a few disks, use the specially designed cardboard shipping envelopes. If you must ship a large number of disks, make sure the box you use is sturdy enough to protect the disks from damage. A good rule of thumb is to use a shipping box that allows you to place 2 inches of packing material around the disks.
- DO NOT touch any exposed recording surfaces. Something as simple as a fingerprint can destroy the data on a floppy disk.
- DO NOT expose a floppy disk to magnetic fields. Telephones, magnetic copy holders, printers, and other electronic equipment generate magnetic fields that can destroy the data on a floppy disk.
- DO NOT expose floppy disks to extreme heat or cold. Floppy disks will last longer if they're stored in an environment that stays around 70-80 degrees Fahrenheit and 30-60 percent relative humidity.

### **Floppy Disk Erasing**

There are two ways to erase a floppy disk: (1) degauss it and then reformat it, or (2) just reformat it. The process for degaussing floppy disks is the same as for degaussing magnetic tape. Refer back to chapter 2 for the details on this.

If the floppy disks were used to store classified, or unclassified but *sensitive* information, they can't be de-classified by erasing them. This is because, with the right equipment and software, the data that was on the disk can be reconstructed. Floppy disks are cheap and easy to replace. If you can't re-use the floppy disks to store other classified data, just destroy them, using the procedures in OPNAVINST 5510.1, *Don Information and Personnel Security Program Regulation*.

- Q1. Floppy disks are manufactured in what three sizes?*
- Q2. What type of floppy disk is made to store data on both sides of the disk?*
- Q3. What are the three levels of floppy disk density?*
- Q4. What is the storage capacity of a 5-1/4" double-sided, high-density floppy disk?*
- Q5. The floppy disks you are using have a rating of 96 TPI. What does this mean?*
- Q6. The process of formatting a floppy disk is called what type of sectoring?*

Q7. What three components determine the address that locates where on a floppy disk the computer will store the data?

Q8. Why should you always store floppy disks in their envelopes?

Q9. Why should you never place floppy disks near telephones or other electronic equipments that generate magnetic fields?

Q10. What are the two ways to erase floppy disks?

## FIXED MAGNETIC RECORDING DISKS

Fixed disks, or *hard disks* as they're more commonly called, are expensive, rigid, semi-portable, magnetic storage mediums. They have the following characteristics:

### Hard Disk Construction

Most hard disks are made of aluminum platters coated on both sides with either *iron oxide* or *thin-film metal* magnetic coatings. The first type, iron oxide, is the most common (you can recognize this coating by its rust color). This is the same oxide coating that's used on magnetic tape. The second type of coating, thin-film metal, is the newer and better of the two. This coating is a microscopic layer of metal that's bonded to the aluminum platter. You can recognize it by its shiny silver color. Thin-film metal-coated hard disks are becoming more and more popular because they allow more data to be stored in less space.

Hard disks can hold a lot of data, the smallest disk being 10,000,000 bytes, and the largest being about 2,500,000,000 bytes (and they're working on larger ones).

Hard disk platters come in many sizes, ranging from 14" to 2". The most common sizes are 3-1/2", 5-1/4" and 14". The first two sizes are usually used with smaller personal computers. The 14" size is usually used with the larger *mini* and *mainframe* computers.

Most hard disk drives use more than one hard disk platter to store data. These are called *disk packs*. Some hard disk drives use removable hard disk platters. These can use just one platter, or they can use disk packs containing many platters. Most of the multi-platter *removable* hard disk drives in use today use 14" hard disk platters. Figure 8-4 shows a hard disk-pack.

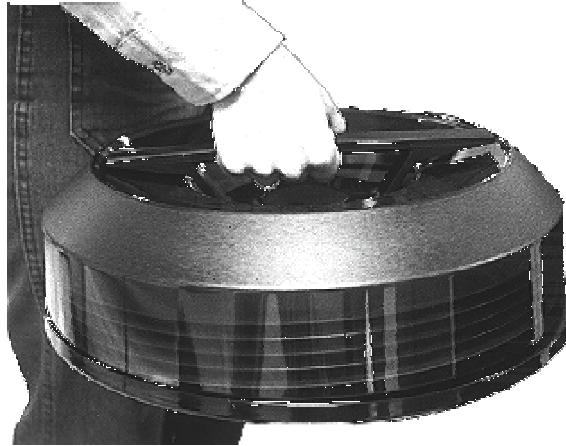

Figure 8-4.—Magnetic hard disk pack.

### Hard Disk Data Organization

Data is stored on a hard disk the same way it's stored on a floppy disk, in circular tracks. The total number of tracks on a hard disk is set, just like floppy disk, by (1) the number of steps the disk drive's magnetic head stepper motor can make, and (2) whether the disk drive has a magnetic head for one or both surfaces of the hard disk platter.

A computer places data on a hard disk using one of two methods, either (1) the *cylinder* method, or (2) the *sector* method. The manufacturer of the hard disk drive decides which method to use.

**THE CYLINDER METHOD.**—This method uses a *cylinder* as the basic reference for placing data on a hard disk. Look at figure 8-5 view A. This is a picture of a disk pack containing six hard disk platters. Notice that this particular disk drive uses only 10 out of the 12 available recording surfaces. If you imagine that you're looking down through the disk pack from above, the tracks with the same number on each of the 10 recording surfaces will line up. Put together, these tracks make up a *cylinder*. Each of these 10 tracks with the same number, one on each recording surface, can be read from and written to by one of the disk drive's 10 read/write magnetic heads that are positioned by the five access arms.

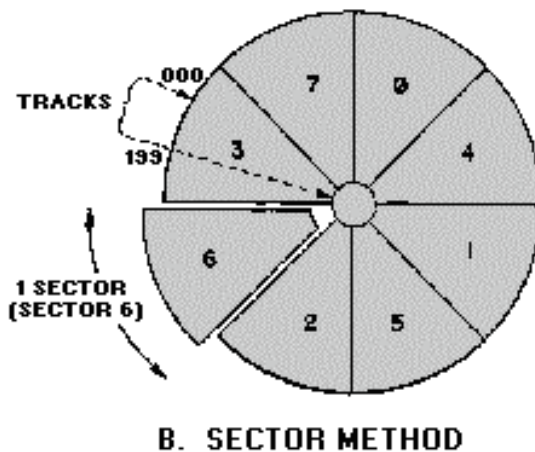
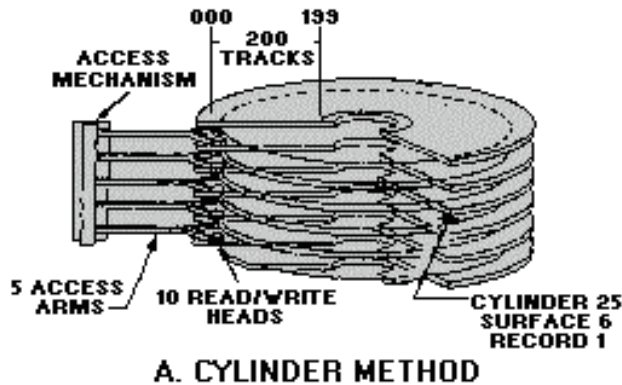

Figure 8-5.—Cylinder and sector method of organizing data on a hard disk pack.

So, to locate a place to store data using the cylinder method, a computer must specify the *cylinder number*, the *recording surface number*, and the *record number*. Figure 8-5 view A shows record number 1 stored on cylinder 25 of recording surface number 6. Special data is stored on each track to tell the computer where the start of a track is.

**THE SECTOR METHOD.**—Although we talked about this method earlier under the heading "Floppy Disk Data Organization," we need to repeat it here as it also applies to hard disks.

The sector method of organizing data on a hard disk is actually a variation of the *cylinder* method. As you already know, the sector method slices up a hard disk into *pie-shaped* slices (just like floppy disks). The total number of slices is set by the hard disk drive manufacturer. Figure 8-5 view B shows an example of the sector method.

Unlike a floppy disk drive, which locates a place on the disk using the *surface number*, *track number*, and *sector number*, a hard disk drive locates a place on the disk by using the *surface number*, *cylinder number*, and *sector number*. This is true even if the hard disk has only one platter. That's because both surfaces of that one platter still form a cylinder.

### Hard Disk Handling, Storage, and Shipping

Hard disks hold a lot more data than floppy disks; even the lowest capacity hard disk can hold 5,000 pages of data! That's why it's important to handle, store, and ship hard disks properly. If you think 180 pages of data is a lot to retype, just think of retyping 5,000 pages!

Hard disk drives spin at a very high speed of about 3600 RPM. It is extremely important that nothing gets between the head and the recording surface. If it does, you can lose data and you can damage both the magnetic head and the disk's recording surface.

Most hard disk failures involve a *head-crash*. It's the worst thing that can happen to a hard disk. A head-crash is the result of the disk drive's magnetic heads *crashing* into the recording surface and grinding into the hard disk platter. Figure 8-6 shows a good hard disk platter and a bad hard disk platter that was the victim of a head-crash.

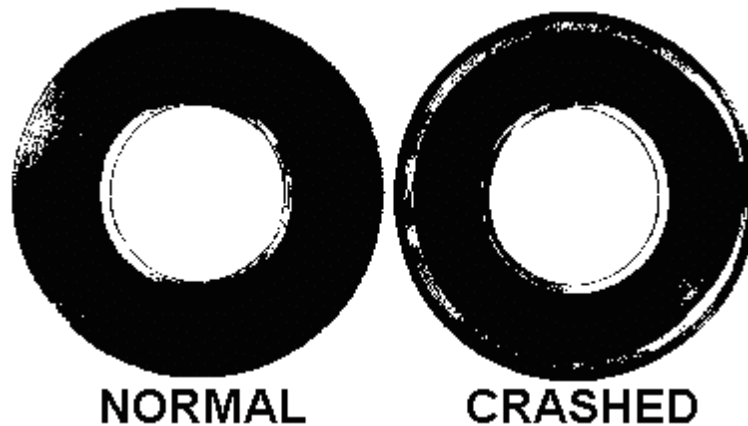

Figure 8-6.—Example of a hard disk crash.

You must handle, store, and ship hard disks with extreme care if you want them to stay in good condition. Here are some specific precautions you should take:

- DO always store removable hard disks in their storage cases when not in use. Dirt, dust, etc., can get on the recording surface through the magnetic head read/write access hole if you leave it exposed for any length of time.
- DO always handle hard disks with extreme care. DO NOT drop them. Even a small drop of 2" can warp a hard disk platter enough to cause a head crash.
- DO always keep removable hard disks away from food, liquids, and cigarette smoke. All of these can easily cause damage.
- DO always ship hard disks in their proper shipping containers. If you don't have the original shipping container, make sure the shipping box is sturdy and big enough to allow 2" of packing material around the disk. Save the original packing material for the hard disk just in case you need to ship it somewhere.
- DO NOT touch any exposed recording surfaces. Something as simple as a fingerprint can cause a head crash and destroy a hard disk platter.
- DO NOT expose hard disks to extreme heat or cold. Hard disks will last longer if they're stored in an environment that stays around 70-80 degrees Fahrenheit and 30-60 percent relative humidity.

### Hard Disk Erasing

There are two ways to erase a hard disk: (1) degauss it and then reformat it, or (2) just reformat it. As you might guess, the first method can only be used for removable hard disk platters. The second method

(reformatting) is the most common. If you must degauss a removable hard disk, the process is the same as degaussing magnetic tape. Refer back to chapter 2 for the details on this.

If the hard disks were used to store classified information or unclassified but *sensitive* information, you can't de-classify the hard disks by erasing them. This is because with the right equipment and software, the data that was on the disk can be reconstructed. If you can't re-use the hard disks to store other classified data, you must sanitize or destroy them, using the procedures in OPNAVINST 5510.1.

*Q11. What are the three most common sizes of hard disk platters?*

*Q12. Computers use what two methods to place data on a hard disk?*

*Q13. Which method for placing data on hard disks divides a hard disk into pie shaped slices?*

*Q14. When computers use the cylinder method to store data on a hard disk pack, what three items make up the address that tells the computer where on a specific disk to store the data?*

*Q15. What is the most common type of hard disk failure?*

*Q16. Hard disks should be stored in an environment that stays within what relative humidity and temperature range?*

*Q17. What is the most common method for erasing a hard disk?*

## **RECORDING DIGITAL DATA ON MAGNETIC DISKS**

Digital data is stored on a magnetic disk using magnetic pulses. These pulses are generated by passing a frequency modulated (FM) current through the disk drive's magnetic head. This FM current generates a magnetic field that magnetizes the particles of the disk's recording surface directly under the magnetic head. The pulse can be one of two polarities, *positive* or *negative*.

Digital data isn't just recorded onto a magnetic disk as-is. Instead, it's encoded onto the disk. Three of the most popular encoding methods are (1) *frequency modulation (FM)*, (2) *modified frequency modulation (MFM)*, and (3) *run length limited (RLL)*. The following paragraphs describe each of these encoding methods.

### **FREQUENCY MODULATION (FM) ENCODING**

The FM method of encoding digital data onto a disk uses two pulse periods to represent each bit of data (a pulse period is the time span of one pulse). The first pulse period always contains a *clock* pulse. The second pulse-period may, or may not, contain a *data* pulse. If the digital data is a "1," a data pulse will be present in the second pulse-period. But, if the digital data is a "0," then there's no pulse present. Figure 8-7 shows this. The clock pulse, which is always present, tells the disk drive's interface that the next pulse is a data pulse. It is used to compensate for changes in the disk's rotation speed.

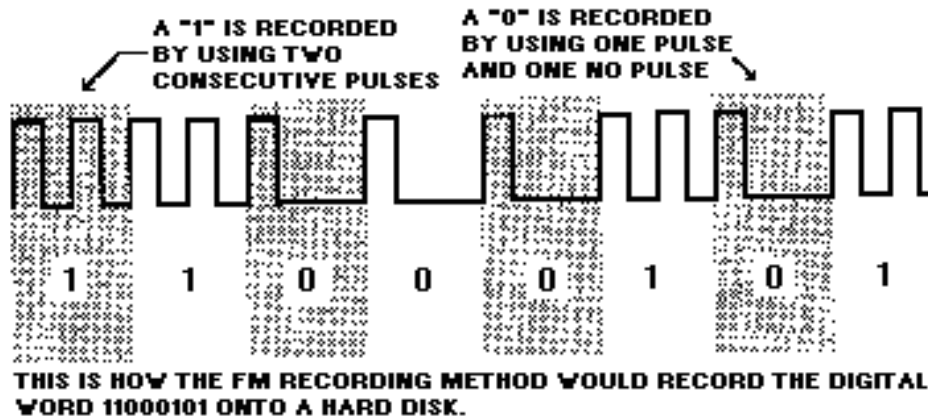

Figure 8-7.—Frequency-modulation (FM) encoding.

The FM method of encoding is old, and isn't used much anymore. You'll only see it in some of the older single-sided, single-density floppy disk drives, and in some of the older military hard disk drives.

#### MODIFIED FREQUENCY-MODULATION (MFM) ENCODING

The MFM method of encoding digital data onto a disk is more popular because it is more efficient and more reliable than straight FM encoding.

MFM encoding still uses two pulse periods, but uses a lot fewer pulses to store the digital data onto the disk. It does this in two ways:

1. It does away with the clock pulse that the FM method uses.
2. It stores a digital "1" by generating a *no-pulse* and a *pulse* in the two pulse periods. It stores a digital "0" as either a *pulse and a no-pulse* if the last bit was a "0," or as two *no-pulses* if the last bit was a "1." Figure 8-8 shows this.

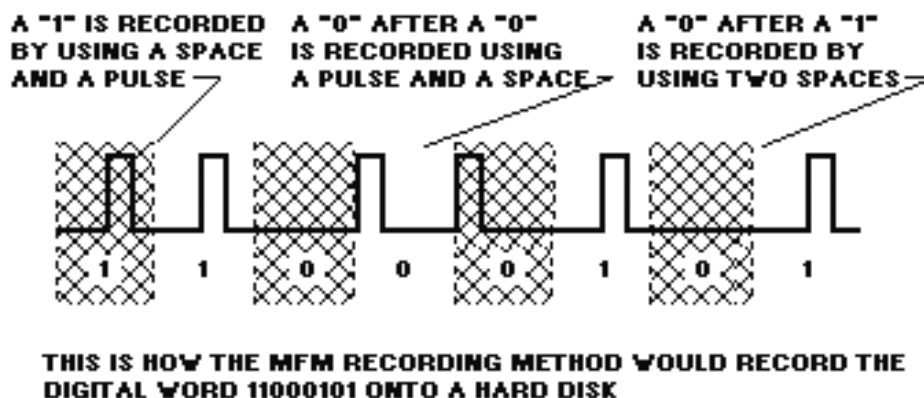

Figure 8-8.—Modified frequency-modulation (MFM) encoding.

## RUN LENGTH-LIMITED (RLL) ENCODING

The RLL method of encoding digital data onto a disk is actually a refinement of the MFM encoding method. As its name implies, RLL *limits* the *run length* (distance) between pulses (also called *flux reversals*) on a hard disk. The basic theory of RLL encoding is that you can store more data in less space if you reduce the number of flux reversals (or pulses) that you must record.

There are several versions of the RLL encoding method, the most popular version being the 2,7 RLL. This means that no fewer than 2 *no-pulses* and no more than 7 *no-pulses* can occur between pulses.

## MAGNETIC DISK DRIVE TRANSPORTS

Magnetic disk drive transports, like magnetic tape drive transports, move the magnetic disks across the magnetic heads and protect the disks from damage. The following paragraphs will (1) introduce you to the characteristics of both floppy and hard disk drive transports, and (2) describe their preventive maintenance requirements.

### FLOPPY DISK DRIVE TRANSPORTS

Floppy disk drive transports contain the electromechanical parts that (1) rotate the floppy disk, (2) write data to it, and (3) read data from it. Figure 8-9 shows a typical floppy disk drive transport. Four of the drive transport's more important parts are the

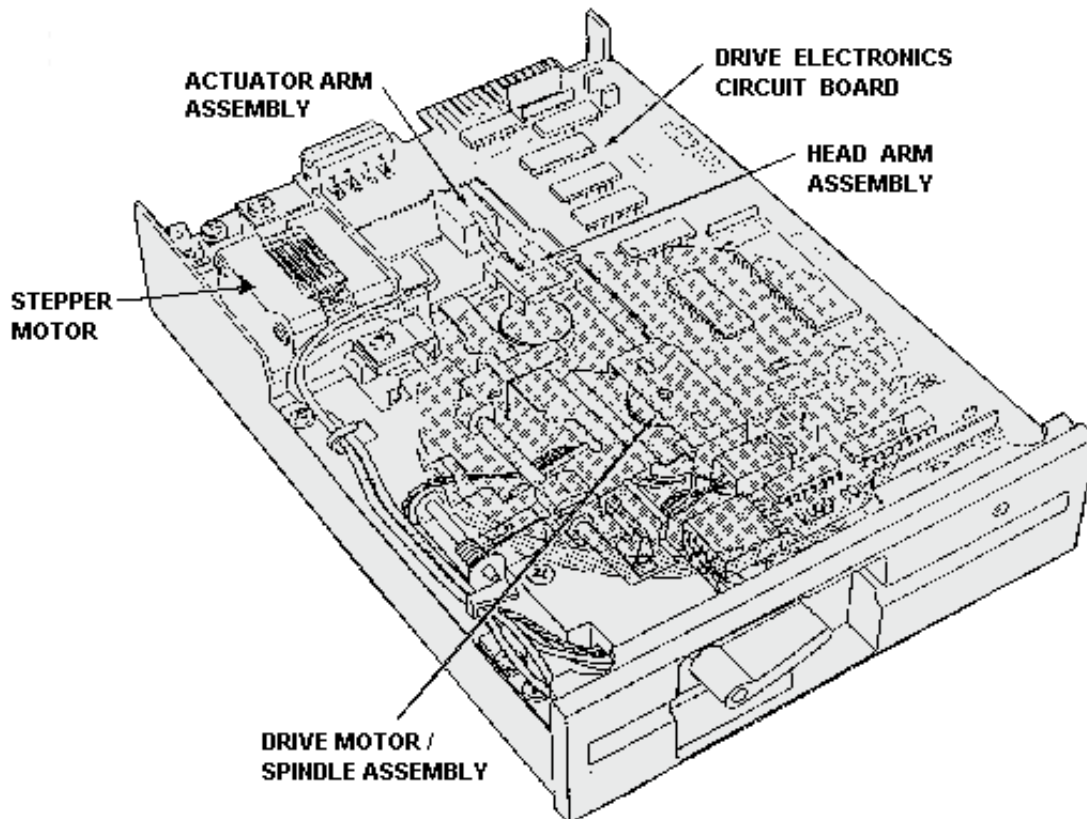

Figure 8-9.—Typical floppy disk drive transport.



1. drive motor/spindle assembly,
2. head arm assembly,
3. actuator arm assembly, and
4. drive electronics circuit board.

### **Drive Motor/Spindle Assembly**

The spindle in this assembly holds the floppy disk in place while it spins. The drive motor spins the spindle at 300 to 600 RPM, depending on the type of floppy disk drive. The following is a list of the types of floppy disk drives and the spinning speeds of their spindles.

<u>FLOPPY DISK DRIVE TYPE</u>	<u>SPINNING SPEED</u>
5-1/4" 360-KB storage	300 RPM
5-1/4" 1.2-MB storage	360 RPM
3-1/2" 720-KB storage	600 RPM
3-1/2" 1.44-MB storage	600 RPM

The spindle of a 5-1/4" disk drive is activated and released by a small arm that's mounted on the front of the disk drive. You must turn the small arm to *lock* and *release* the floppy disk.

The spindle of a 3-1/2" disk drive is activated when the floppy disk is inserted into the disk drive. It's released by a push-button that's located on the front of the disk drive. When you push this button, the floppy disk is released and pops out of the disk drive.

### **Head Arm Assembly**

This part of a floppy disk drive transport holds the magnetic read/write heads. There are four heads on a head arm assembly, two *write* heads and two *read* heads - one of each for each recording surface. The head arm assembly is attached to the actuator arm assembly.

### **Actuator Arm Assembly**

The actuator arm assembly *positions* the magnetic heads over the recording surface of the floppy disk. It does this by using a special type of dc motor called a *stepper motor*. This motor, which can be moved in very small *steps*, allows the read/write heads to be moved from track to track as needed to write data onto and read data off of the floppy disk.

### **Drive Electronics Circuit Board**

This circuit board contains the circuitry which (1) controls the electromechanical parts of the disk drive transport, (2) writes data to and reads data from the floppy disk, and (3) interfaces the floppy disk drive to the host computer.

## HARD DISK DRIVE TRANSPORTS

Hard disk drive transports contain the electromechanical parts that (1) rotate the hard disk platter, (2) write data to it, and (3) read data from it.

There are two types of hard disk drive transports, *fixed disk* and *cartridge disk*. Fixed disk drive transports use *non-removable* hard disk platters. Cartridge-disk drive transports use *removable* hard disk platters that are built into protective cartridges. These two transports serve very different purposes, but they each contain the same basic parts. Figure 8-10 shows a typical hard disk drive transport. Four of the more important parts of a hard disk drive transport are the

1. drive motor/spindle assembly,
2. head arm assembly,
3. actuator arm assembly, and
4. drive electronics circuit board.

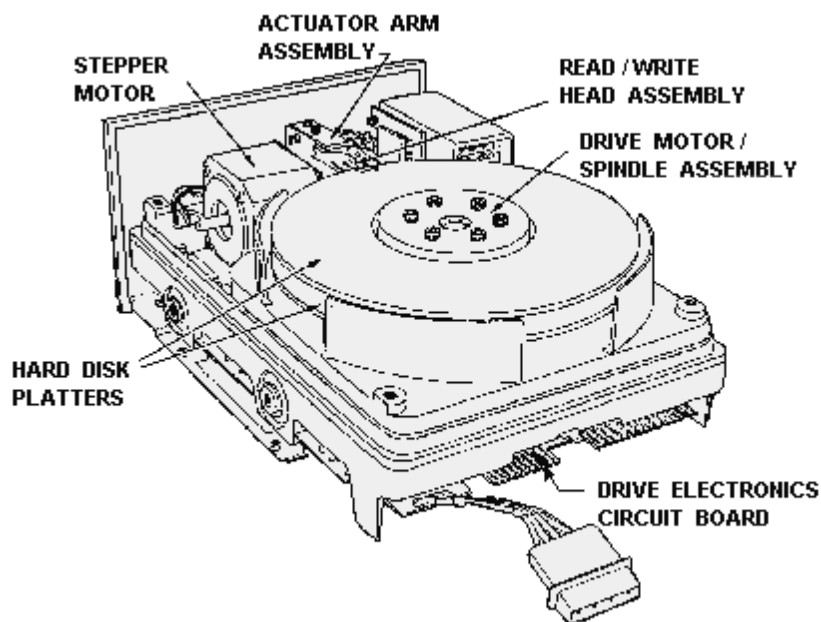

Figure 8-10.—Typical hard disk drive transport.

### Drive Motor/Spindle Assembly

This assembly holds and spins the hard disk pack. The spindle assembly holds the hard disk pack in place and the drive motor spins the spindle at 3600 RPM. On cartridge disk drives, the spindle is *electronically* disengaged to release the disk pack so it can be removed.

## Head Arm Assembly

This part of the hard disk drive transport holds the magnetic read/write heads. There is a separate head arm assembly for each of the hard disk platters in the disk pack. Each assembly has four magnetic heads, two *write* heads and two *read* heads—one pair of heads for each surface of the hard disk platter. The head arm assembly is attached to the actuator arm assembly.

## Actuator Arm Assembly

This part of the hard disk drive transport *positions* the magnetic heads so they can write data to and read data from the correct track of the hard disk. It does this by using either a *stepper motor* or a *voice coil servo*. A stepper motor is a special type of dc motor which can be moved in very small *steps* to accurately position the magnetic heads. A voice coil servo by itself cannot move the magnetic heads from track to track. Instead, it must use special signals called *servo signals* to make sure it's positioning the heads where they should be. The *servo signals* are pre-recorded signals which are stored on either the same hard disk platter as the data or on a separate hard disk platter.

The voice coil servo method of moving the magnetic heads to the correct track of the hard disk is also called *embedded servo control*. This type of control is becoming very popular because voice coil actuator assemblies can position the magnetic heads much quicker and more accurately than dc stepper motors.

## Drive Electronics Circuit Board

This circuit board contains the circuitry which (1) controls the electromechanical parts of the hard disk drive transport, (2) writes data to and reads data from the hard disk, and (3) interfaces the hard disk drive to the host computer.

- Q18. What are the three most popular methods for encoding digital data onto magnetic disks?*
- Q19. Older, single-sided, single-density floppy disk drives would probably use what method for encoding digital data onto the floppy disk?*
- Q20. What method for encoding digital data enables you to store more data in less space by limiting the distance between pulses on a hard disk?*
- Q21. What are the four most important parts of a floppy disk drive transport?*
- Q22. The drive motor of a 3-1/2", 1.44-MB floppy disk drive spins the disk at what RPM?*
- Q23. The head arm assembly of a floppy disk drive transport has how many read heads and how many write heads?*
- Q24. What part of a floppy disk drive transport uses a dc stepper motor to position the magnetic heads over the recording surface of a floppy disk?*
- Q25. What part of a floppy disk drive transport contains the circuitry which controls the electromechanical parts of the transport?*
- Q26. Hard disk drive transports contain the electromechanical parts that perform what three functions?*
- Q27. In the actuator arm assembly of a hard disk drive transport, what device can position the magnetic heads to the correct track of a hard disk more accurately than a dc stepper motor?*

## MAGNETIC DISK DRIVE PREVENTIVE MAINTENANCE

Like magnetic tape recorders, if you want a magnetic disk drive to continue storing and retrieving data without errors, you must periodically perform preventive maintenance. Fortunately, disk drives require less maintenance than magnetic tape drives. The following paragraphs describe the preventive maintenance requirements for both *floppy* and *hard* disk drives.

### FLOPPY DISK DRIVE PREVENTIVE MAINTENANCE

Of all of the magnetic disk drives in use today, floppy disk drives require the most maintenance. This is because they are not sealed units like most hard drives and because they use flimsy plastic disks that are coated with the same type of oxide as magnetic tape.

It's this oxide that causes most of the problems you'll have with floppy disk drives. Just as with magnetic tape, the oxide coating wears off of the plastic backing and sticks (mainly) to the magnetic heads. This contamination causes dropout errors which have much graver consequences than with magnetic tape. It can cause a program to crash, or even worse — it can destroy your valuable data.

To prevent this, you must *periodically* clean the floppy disk drive's magnetic heads. There are many kits available to do the job. A kit has a cleaning disk and a bottle of cleaning solution. A cleaning disk looks just like a regular disk, except that instead of an oxide-coated disk, it has a cloth or fiber cleaning disk inside the protective jacket. The instructions that come with the cleaning kit will lead you through the cleaning process. Here is an example of the cleaning procedures for a floppy disk drive's magnetic heads:

1. Pour some of the cleaning solution onto the cleaning disk through the access hole in the protective jacket.
2. Insert the cleaning disk into the disk drive.
3. Exercise the disk drive for at least 30 seconds.
4. Remove the disk from the disk drive.

There are also some cleaning kits that use disposable cleaning disks. These kits will instruct you to clean the heads as follows:

1. Open the sealed envelope that contains a cleaning disk soaked in cleaning solution.
2. Insert the cleaning disk into the protective jacket provided.
3. Insert the cleaning disk (with protective jacket) into the disk drive.
4. Exercise the disk drive for 30 seconds.
5. Remove the disk from the disk drive.
6. Remove the cleaning disk from the protective jacket and throw it away.

Now comes the question "How often must I clean the heads?" That's hard to say. It depends on the type of disk drive, the quality of the floppy disks you use, and how much you use the disk drive. On the average, you should clean a floppy disk drive

- once a month if it gets heavy use,
- once every 6 months if it gets moderate use, or

- once a year if it gets very little use.

## **HARD DISK DRIVE PREVENTIVE MAINTENANCE**

Hard disk drives need little or no preventive maintenance. If it's a *fixed* hard disk drive, it doesn't need preventive maintenance because it's a sealed unit that you must not open for any reason. If it's a *cartridge* disk drive, the manufacturer will have a special cleaning disk with instructions for doing the preventive maintenance. The Navy uses some larger cartridge disk drives, such as the 14" disk pack drives, that require some other preventive maintenance. This could include the following:

- Cleaning air filters.
- Cleaning spindles, rails, and slides.
- Cleaning and buffing read and write heads.

The technical manual for the disk drive will guide you through this type of preventive maintenance.

*Q28. Why do floppy disk drives require more preventive maintenance than hard disk drives?*

*Q29. A kit for cleaning floppy disk drives contains what two items?*

*Q30. Approximately how often should you clean a floppy disk drive that gets heavy use?*

*Q31. Cartridge hard disk drives with 14" disk packs may require what additional types of preventive maintenance?*

## **MAGNETIC DISK DRIVE ELECTRONICS**

Magnetic disk drive electronics consist of three main parts:

1. Control electronics to control the electromechanical parts of a disk drive.
2. Write/read electronics to write data to and read data from a disk drive.
3. Interface electronics to interface the disk drive to the host computer.

Some disk drives require a separate *controller card*. When this is true, some of the drive electronics are part of the disk drive itself, and some are part of the host computer's controller card.

As different as disk drives can be (floppy, fixed, cartridge, etc.), their electronics is surprisingly similar. That's why the following paragraphs will only *very basically* describe these three main parts.

### **CONTROL ELECTRONICS**

The main functions of a disk drive's control electronics are to:

- Spin the disk at the proper speed.
- Move the magnetic heads across the recording surface.
- Tell write/read heads when to write data and when to read data.

## WRITE/READ ELECTRONICS

The write/read electronics consists of the *write* part and the *read* part. The *write* part takes incoming data from the interface electronics, formats it as needed, and writes it onto the disk. The *read* part reads the data off of the disk, formats it as needed, and sends it to the interface electronics for output to the host computer. The write/read electronics also performs the initial disk formatting function.

## INTERFACE ELECTRONICS

Interface electronics do two things:

1. Receive control signals from the host computer that tells them to spin the disk, move the magnetic heads, write/read data, format a disk, etc.
2. Convert the incoming and outgoing data as needed.

A disk drive is a *serial* device. This means the data stored on the disk is stored in a serial pulse-train format. But the data coming from the disk drive and going to the host computer needs to be in a *parallel* data format. The interface electronics converts the data from parallel to serial, and vice versa, as needed.

There are many types of disk drive interfaces in use today. The five most common ones are the:

1. Naval Tactical Data System (NTDS) interface.
2. ST-506/412 interface.
3. Enhanced small device interface (ESDI).
4. Small computer systems interface (SCSI).
5. Integrated drive electronics (IDE).

The following paragraphs describe each of these interfaces.

### Naval Tactical Data System (NTDS) Interface

The NTDS interface is used by many naval electronic warfare systems. There are three versions of this interface:

1. NTDS FAST: A parallel interface that can transfer data at a rate of 250,000 32-bit words per second.
2. NTDS SLOW: A parallel interface that can transfer data at a rate of 41,667 32-bit words per second.
3. NTDS SERIAL: A serial interface that can transfer data at a rate of 10 million bits (Mbits) per second.

### ST-506/412 Interface

The ST-506/412 interface was developed by Seagate Technology, Inc. It's often used in the hard disk drives installed in older IBM-compatible desktop computers that have a maximum capacity of 125 MB. It's also the interface used to control most floppy disk drives in use today.

This is one of the interfaces where most of the electronics is actually on a *controller card* mounted in the host computer. With this interface, the controller card does most of the work (moving the magnetic head, spinning the disk, etc.). The controller card also cleans any data coming from the disk drive by stripping off the formatting and control signals that were used to store the data onto the hard disk.

A hard disk drive is connected to the controller card in the host computer via two ribbon cables (a 34-pin control cable and a 20-pin data cable). Floppy drives use only the 34-pin control cable to transfer both data and control signals.

When this interface was originally developed in 1981, its 5-Mbits per second transfer rate was considered *too fast*. They actually slowed it down by using a 6:1 interleave factor (we'll define this later) so it could operate with the computers being built at that time. With today's transfer rates pushing the envelope at 24 Mbits per second, you can see that it's now one of the slowest interfaces.

### **Enhanced Small Device Interface (ESDI)**

The ESDI is an optimized version of the ST-506/412 interface. The main difference is that with ESDI, most of the disk drive's interface electronics is located in the disk drive itself, rather than on a controller card in the host computer. The result is a much faster transfer rate and more hard disk capacity. ESDIs have a transfer rate of up to 24 MB per second. And, they can handle disk drives with a maximum capacity of 1.2 GB (gigabytes).

The ESDI uses the same interface cables as the ST-506/412 interface, but that's where the similarity ends. With ESDI drives, only the *clean* data is sent to the controller card in the host computer. All formatting and control signals are stripped off at the hard disk drive.

### **Small Computer Systems Interface (SCSI)**

The SCSI (pronounced *skuzzy*) is very different from both the ST-506/412 and the ESDI. The SCSI is an 8-bit, parallel, high-level interface. *High-level* means that instead of a host computer asking for data by specifying a track, cylinder, and sector number, all it asks for is a logical sector number. The SCSI then translates the logical sector number into the actual disk location.

The SCSI also has other improvements over the previous disk drive interfaces. For example, it can:

- Transfer data at rates of up to 4 MB per second.
- Handle hard disk drives of almost any size.
- *Disconnect* itself from a host computer's bus while it processes requests. This frees-up the host computer to do other things.
- *Daisy-chain* up to eight units off of one controller.

The SCSI interface uses one 50-pin ribbon cable to connect the hard disk drive(s) to the controller card mounted in the host computer. Some computer manufacturers include the SCSI electronics in their motherboards and do away with a separate controller card altogether. This interface got its big break when Apple Computer Corporation used the SCSI as its hard disk drive interface in its MacIntosh computers.

## **Integrated Drive Electronics (IDE)**

The IDE is the newest interface available. It was developed as a result of trying, to find a cheaper way to build computer systems. It includes all of the controller card electronics in the hard disk drive itself, thus, the hard drive does all the work.

The hard disk drive connects to the host computer's bus with a 40-pin ribbon cable. The ribbon cable connects directly to either a 40-pin connector on the host computer's motherboard or a 40 pin connector on a small interface card that plugs into the host computer's motherboard. This interface offers a transfer rate of up to 1 MB and can handle hard drives with a maximum capacity of 300 MB.

## **MAGNETIC DISK RECORDING SPECIFICATIONS**

Think back to the chapter 6 on "Magnetic Tape Recording Specifications." Do you remember how to measure and adjust them if needed? Well, magnetic disk recording specifications are a little different. They're set by the manufacturer and you can't change them. All you can do is measure them. The following paragraphs describe six of the most common specifications.

### **SEEK TIME**

The *seek time* is the amount of time it takes for the magnetic head to position itself over a specific track of a magnetic disk. It's usually stated in milliseconds.

### **LATENCY PERIOD**

The *latency period* is the amount of time it takes for a specific sector of a specific track to position itself under the magnetic head. It too, is usually stated in ms.

### **ACCESS TIME**

The *access time* is the sum of the seek time and the latency period. It's the total amount of time in ms that it takes a disk drive to retrieve a sector of data from the magnetic disk. Access time is stated in one of the following three ways:

1. Track-to-track seek time: This is the amount of time it takes a disk drive to access data from a track next to the track it's presently over.
2. Average seek time: This is the amount of time it takes a disk drive to access data that's located one-third of the way across the magnetic disk.
3. Maximum seek time: This is the amount of time it takes a disk drive to access data from the last track of a magnetic disk when it's presently on the first track of the magnetic disk.

### **INTERLEAVE FACTOR**

The *interleave factor* applies only to hard disk drives. They spin at 3600 RPM, a very fast speed compared to floppy disk drives which only spin at 300-600 RPM. Interleave indicates how many physical sectors are between sequentially numbered logical sectors on a hard disk. It's used when the magnetic heads and the control circuitry can't process the data fast enough to sequentially number the sectors on a hard disk platter. With interleave, the magnetic head is told to *skip* X number of sectors to get to the *next* one. For example, a hard disk with 17 sectors per track and no interleave is numbered 1, 2, 3, 4... 17. The same hard disk with an interleave factor of 3 is numbered 1, 7, 13, 2, 8, 14, 3, 9, 15, 4, 10, 16, 5, 11, 17, 6,



12, and then back to 1. If you count every third sector, they're sequential. The most efficient hard disk drives have *no* interleave.

## TRANSFER RATE

The *transfer rate* states how fast a disk drive and a disk drive controller (working together) can transfer data to the host computer. An example of a transfer rate specification is "2 Mbits/sec," or two million bits per second. The higher the number, the faster the data transfer rate.

## RECORDING DENSITY

The *recording density* states how close together bits can be stored on the recording surface of a magnetic disk. It determines two things: (1) How close together the tracks on the disk will be, and (2) how close together the bits on each track will be. An example of a recording density specification is "12 Mbits/in<sup>2</sup>," or 12 million bits per square inch.

- Q32. *The control electronics component of a floppy or hard disk drive performs what three main functions?*
- Q33. *The write/read electronics of a disk drive performs what three functions?*
- Q34. *The interface electronics of a disk drive performs what three functions?*
- Q35. *What type of interface electronics is used in many naval electronic warfare systems?*
- Q36. *What type of disk drive interface has most of the electronics on a controller card mounted in the host computer?*
- Q37. *The SCSI is a high level disk drive interface. What does this mean?*
- Q38. *What type of hard disk drive interface has all of the controller card electronics included in the disk drive itself?*

## SUMMARY

Now that you've finished chapter 8, you should be able to describe the (1) characteristics of floppy and hard disks, (2) methods for encoding digital data onto magnetic disks, (3) disk drive transports and their preventive maintenance requirements, (4) parts of a disk drive's electronics component, and (5) common types of disk drive interface electronics. The following is a summary of important points in this chapter:

**FLOPPY DISKS** are single-sided or double-sided plastic disks coated with oxide particles. The disks can be *single-density*, *double-density*, or *high density*.

Data is stored on floppy disks in **CIRCULAR TRACKS**. The tracks are divided into arcs called **SECTORS**.

**HANDLE, SHIP, and STORE** floppy disks carefully. Contaminates between the heads and the disk surface can cause serious damage.

**FIXED (HARD) DISKS** are aluminum platters coated on both sides with iron oxide or thin-film metal. Most hard disk drives use *disk packs* which are several disk platters stacked together. Some hard disk drives use removable disk platters.

Either the **CYLINDER OR SECTOR METHOD** is used to place data on hard disks.

**HANDLE, STORE, AND SHIP HARD DISKS** with extreme care. Contaminates on the heads or the disk surface can cause *head-crash*.

**ERASE HARD AND FLOPPY DISKS** by reformatting or degaussing.

Three popular **METHODS FOR ENCODING DIGITAL DATA ONTO DISKS** are frequency modulation, modified frequency modulation, and run length limited.

**FLOPPY DISK DRIVE TRANSPORTS** contain the parts that (1) spin the floppy disk, (2) write data to the disk, and (3) read data from it.

The **DRIVE MOTOR/SPINDLE ASSEMBLY** of a floppy disk drive transport holds and spins the floppy disk. The transport's **HEAD ARM ASSEMBLY** holds the read/write heads and its **ACTUATOR ARM ASSEMBLY** positions the heads over the disk's recording surface.

**HARD DISK DRIVE TRANSPORTS** contain the parts that (1) rotate the hard disk platter, (2) write data to the disk, and (3) read data from the disk.

The **DRIVE MOTOR/SPINDLE ASSEMBLY** of a hard disk drive transport holds the disk pack in place while the drive motor spins the spindle at 3600 RPM. The transport's **HEAD ARM ASSEMBLY** holds the read/write heads and its **ACTUATOR ARM ASSEMBLY** positions the heads over the correct track of the hard disk.

**FLOPPY DISK DRIVES REQUIRE PREVENTIVE MAINTENANCE** at regular intervals because they are not sealed units and the disks use an oxide coating that wears off and sticks to the heads and other parts.

**HARD DISK DRIVES REQUIRE VERY LITTLE PREVENTIVE MAINTENANCE.** Cartridge disk drives will have a special cleaning kit for doing the preventive maintenance.

Magnetic **DISK DRIVE ELECTRONICS** consist of (1) *control electronics* to control the electromechanical parts of a disk drive, (2) *write/read electronics* to write data to and read data from a disk drive, and (3) *interface electronics* to interface the disk drive to the host computer.

**MAGNETIC DISK RECORDING SPECIFICATIONS** are set by the manufacturer; all you can do is measure them. Six of the most common specifications are *seek time*, *latency period*, *access time*, *interleave factor*, *transfer rate*, and *recording density*.

### **ANSWERS TO QUESTIONS Q1. THROUGH Q38.**

A1. 8 inch, 5 1/4 inches, 3 1/2 inches.

A2. Double-sided.

- A3.
- a. *Single-density,*
  - b. *double-density, and*
  - c. *high-density.*
- A4. 1,200,000 bytes or 1.2 megabytes.
- A5. The disks can hold 96 tracks per inch.
- A6. Soft sectoring.
- A7.
- a. *disk side number,*
  - b. *track number, and*
  - c. *sector number.*
- A8. *Dust and other contaminants can get on the recording surface through the read/write hole.*
- A9. *Magnetic fields can destroy the data on a disk.*
- A10.
- a. *Degauss the disk and then reformat it.*
  - b. *Reformat the disk.*
- A11. *3-1/2 inches, 5-1/4 inches, and 14 inches.*
- A12. *(1) Cylinder method and (2) sector method.*
- A13. *Sector method.*
- A14.
- a. *Cylinder number.*
  - b. *Recording surface number.*
  - c. *Record number.*
- A15. *Head-crash.*
- A16.
- a. *30-60 percent relative humidity.*
  - b. *70-80 degrees Fahrenheit.*
- A17. *Reformat the disk.*

- A18. *Frequency modulation (FM).*
- a. *Modified frequency modulation (MFM).*
  - b. *Run length limited (RLL).*
- A19. *Frequency-modulation encoding.*
- A20. *Run length-limited (RLL) encoding.*
- A21.
- a. *Drive motor/spindle assembly.*
  - b. *Head arm assembly.*
  - c. *Actuator arm assembly.*
  - d. *Drive electronics circuit board.*
- A22. *600 RPM.*
- A23. *Two read heads and two write heads.*
- A24. *Actuator arm assembly.*
- A25. *Drive electronics circuit board.*
- A26.
- a. *Rotates the hard disk platters.*
  - b. *Writes data to and reads data from the disk platters.*
- A27. *Voice coil servo.*
- A28. *They are not sealed units, and they use flimsy plastic disks with an oxide coating that wears off and sticks to the heads.*
- A29.
- a. *A cloth or fiber cleaning disk.*
  - b. *A bottle of cleaning solution.*
- A30. *Once a month.*

A31.

- a. *Cleaning with a special cleaning disk.*
- b. *Cleaning air filters.*
- c. *Cleaning spindles, rails, and slides.*
- d. *Cleaning and buffing read/write heads.*

A32.

- a. *Spins the disk at the correct speed.*
- b. *Moves the heads across the recording surface.*
- c. *Tells the write/read heads when to write data and when to read it.*

A33.

- a. *Formats and writes incoming data from the interface electronics onto the disk.*
- b. *Reads data off the disk, formats it, and sends it to the interface electronics for output.*
- c. *Performs the initial disk formatting.*

A34.

- a. *Receives control signals from the host computer and sends them to the control electronics or write/read electronics.*
- b. *Receives data from the write/read electronics and outputs it to the host computer.*
- c. *Converts incoming and outgoing data from parallel to serial, and vice versa, if needed.*

A35. *NTDS interface.*

A36. *ST-506/412 interface.*

A37. *The host computer asks for data by specifying a logical sector number. The SCSI translates the sector number into the actual disk location.*

A38. *Integrated drive electronics (IDE).*



# APPENDIX I

## GLOSSARY

**ABRASIVITY**—The ability of the magnetic tape to wear the head.

**ADDITIVE**—Any material in the coating of magnetic tape other than the oxide and binder resins. (Examples: plasticizers (to soften an otherwise hard or brittle binder), lubricants (to lower the coefficient of friction of an otherwise high-friction binder), fungicides (to prevent fungus growth), dispersants (to uniformly distribute the oxide particles), and dyes.)

**ALTERNATING CURRENT (ac) BIAS**—(1) The alternating current, usually of a frequency several times higher than the highest input signal frequency, that is fed to a record head in addition to the input signal current. (2) Linearizes the recording process. (3) Is universally used in direct analog recording.

**AMPLITUDE/FREQUENCY RESPONSE**—(See frequency response.)

**ANALOG RECORDING**—A method of recording in which some characteristic of the record current, such as amplitude or frequency, is continuously varied in a manner similar to the variations of the original signal.

**AZIMUTH ALIGNMENT**—The alignment of the recording and reproducing gaps so their center lines lie parallel with one another. Misalignment of the gaps causes a loss in output at short wavelengths.

**BACKINGS**—(See base film.)

**BANDWIDTH**—The frequency within which the performance of a recorder with respect to some characteristic (usually frequency response) falls within specified limits, or within which some performance characteristic (such as noise) is measured.

**BASE FILM**—The plastic substrate material used in magnetic tape that supports the coating.

**BER**—(See bit error rate.)

**BIAS-INDUCED NOISE** (See noise.)

**BINARY**—(1) Two values ("0" or "1") or states (ON or OFF). (2) The number systems used in computers.

**BINDER**—A compound consisting of organic resins used to bond the oxide particles to the base material, the actual composition being considered proprietary information by each magnetic tape manufacturer. The binder is required to be flexible but still maintain the ability to resist flaking or shedding during extended wear passes.

**BIT**—(1) The acronym binary digit. (2) The smallest unit of data, either "0" or "1". (3) One recorded information cell, as applied in magnetic recording.

**BIT DENSITY**—(See packing density.) bit error rate (BER).—(1) The number of errors a specific magnetic tape may contain, as used in high-density recording. (2) Is expressed in errors per data bit, such as 1 in  $10^6$ , or one error in one million data bits.

**BREAK ELONGATION**—The relative elongation of a specimen of magnetic tape of base film at the instant of breaking when it has been stretched at a given rate.

**BROWN STAIN**—(1) A thin discoloration of the head's top surface, usually a chemical reaction between the head's surface materials and the tape binder, the tape lubricant, or the head's bonding materials. (2) Its origin is not well understood, but is known to occur in low humidity.

**BUCKLING**—(1) A deformation of the circular form of a tape pack. (2) Caused perhaps by a combination of improper winding tension, adverse storage conditions, and/or poor reel hub configuration.

**BUILD-UP**—(1) A snowballing effect started by debris and tape magnetic particles embedded in the contamination. (2) The thickness of this build-up can cause an intense in head-to-tape separation, as well as an increase in the coefficient of friction. (3) Solvent cleaning of the head's top surface will usually remove the build-up.

**BULK-ERASED NOISE**—See noise.

**BULK ERASER (DEGAUSSER)**—An equipment for erasing a full reel of previously recorded signals on tape.

**BYTE**—A group of bits (next to each other) that are considered a unit (example, an 8-bit byte).

**CERTIFIED TAPE**—A tape that is electrically tested on a specified number of tracks and is certified by the supplier to have less than a certain total number of permanent errors.

**CERTIFIER**—(1) An equipment that tests the ability of magnetic tape to record and reproduce. (2) Counts and charts each error on the tape, including the level and duration of dropouts. (3) In the certify mode, stops the tape at an error to allow for visual inspection of the tape to see if the cause of the error is correctable or permanent.

**CHICKEN TRACKS**—(1) A line of small craters in the head's top surface running in the direction of tape motion. (2) Usually caused by a loose, small, hard particle moving with the tape over the head.

**CINCHING**—(1) The tape folds resulting from longitudinal slippage between the layers of tape in a tape pack. (2) Caused by uneven tension when the roll is accelerated or decelerated.

**CLEAN ROOMS**—The rooms of which their cleanliness is measured by the number of particles of a given size per cubic foot of room volume. (Examples (1) A class 100,000 clean room may have no more than 100,000 particles 0.5 fm or larger per cubic foot, and so on for class 10,000 and class 100 rooms. (2) A class 10,000 room may have no more than 65 5-fm particles per cubic foot, while class 100,000 may have no more than 700 5-fm particles per cubit foot.)

**CLEANER**—(See winder/cleaner.)

**COATING**—The magnetic layer of a magnetic tape consisting of oxide particles held in a binder that is applied to the base film.



**COATING RESISTANCE**—(1) The electrical resistance of the coating measured between two parallel electrodes spaced a known distance apart along the length of the tape. (2) Called resistivity on specification sheets.

**COATING THICKNESS**—The thickness of the magnetic coating applied to the base film.

**COATING-TO-BACKING ADHESION**—(See anchorage.)

**CONTAMINATION**—(1) A thick, tacky (viscous) deposit on the head's top surface, which causes a large increase in the effective head-to-tape coefficient of friction. (2) May not be removable by solvent cleaning.

**CORE MATERIAL**—(1) hard core material.—(a) Hard metal laminations bonded together to form the core, with a typical thickness of 0.005 to 0.004 inch. (Hard metal wears much more slowly than soft laminations.) (b) Hard solid metal, such as alphenol or sendust. (Wear rates are much lower than those of soft metal laminations.) (2) soft core material.—(a) Soft metal laminations bonded together to form the core, with a typical thickness of 0.0005 to 0.004 inch. (b) Usually, a high nickel/iron alloy, such as Hy Mu 800. (c) These materials have a relatively poor wear rate.

**CRACK**—A narrow, deep break in the head's surface material.

**CREEP**—The time-dependent strain at a constant stress (tape deformation).

**CROSSFEED**—See crosstalk and write feedthrough.

**CROSSPLAY**—The ability to interchange recordings between recorders while maintaining a given level of performance.

**CROSSTALK**—(1) The magnetic coupling from one track to another in the tape's read/write head. (2) See also write feedthrough.

**CUPPING**—(1) The curvature of a magnetic tape pack in the lateral direction. (2) May be caused by differences between the coefficients of thermal or hygroscopic expansion of coating and base film.

**db**—See decibel.

**dc NOISE**—(See noise.)

**DECIBEL (db)**—A dimensionless unit for expressing the ratio of two powers or voltages or currents on a logarithmic scale. If A and B represent two voltages or currents, the ratio A/B corresponds to  $20 \log A/B$  decibels. One decibel represents a ratio of approximately 1.1 to 1 between A and B. Other values are as follows:

RATIO	DECIBEL
1	0
1.4	3
2	6
4	12
10	20
100	40
1000	60

**DEFECT**—(1) An imperfection in the tape leading to a variation in output or a dropout. (2) The most common defects are surface projections of oxide agglomerates, embedded foreign matter, and redeposited wear products.

**DEGAUSSER**—See bulk eraser.

**DELAY MODULATION**—(See modified frequency modulation.)

**DIGITAL RECORDING**—(1) A method of recording in which the information is first coded in a digital form. (2) Usually, a binary code is used, with recording taking place in two discrete values/polarities of residual flux.

**DIRECT RECORDING**—An analog recording that records and reproduces data in the electrical form of its source.

**DISK**—(1) A disk-drive storage device on which information is magnetically recorded and retrieved. (2) Can be either hard (rigid) or floppy (flexible).

**DISK DRIVE**—A storage device for recording and retrieving data on hard or floppy disks.

**DISK PACK**—A portable, interchangeable device that contains more than one hard-disk platter and is used in hard-disk drives.

**DISPERSION**—The distribution of the oxide particles within a tape's binder.

**DISTORTION**—(see harmonic distortion.).

**DRAG**—The fractional tension differential across the contact area caused when the tape contacts some element in the tape path (such as the head, tape guides, tape bearings, or column walls).

**DROPOUT**—(1) A temporary reduction in the output of a magnetic tape of more than a certain predetermined amount. (2) Expressed in terms of the percentage reduction or decibel loss.

**DROPOUT COUNT**—The number of dropouts detected in a given length of magnetic tape.

**DURABILITY**—The number of passes that can be made before a significant degradation of output occurs, divided by the corresponding number that can be made using a reference tape.

**DYNAMIC**—(See tape skew.)

**DYNAMIC RANGE**—(1) The bandwidth within which a satisfactory signal-to-noise ratio is obtained. (2) See also resolution.

**DYNAMIC SKEW**—The change in skew caused by tape motion.

**DYNAMIC TAPE SKEW**—(See tape skew.)

**EQUIPMENT NOISE**—(See noise.)

**ERASURE**—A process by which a signal recorded on a tape is removed and the tape made ready for rerecording. May be accomplished in two ways. (1) In ac erasure, the tape is demagnetized by an alternating magnetic field that is reduced in amplitude from an initially high value. May be accomplished by passing the tape over an erase head fed with high-frequency ac, or by placing the whole roll of tape in a decreasing ac field (bulk erasure). (2) In dc erasure, the tape is saturated by applying a primarily unidirectional field. May be accomplished by passing the tape over a head fed with dc or over a permanent magnet. Additional stages may be included in dc erasure to leave the tape in a more nearly unmagnetized condition.

**FERRITE**—A powdered and compressed ferric-oxide material that has both magnetic properties and light resistance to current flow.

**FLOPPY DISK**—(See disk.)

**FLUTTER**—(See wow.)

**FLUX**—A term, with reference to electrical or electromagnetic devices, that designates collectively all the electric or magnetic lines of force in a region.

**FLUX DENSITY**—The number of magnetic lines of force passing through a given area.

**FM**—(See frequency modulation.)

**FREQUENCY MODULATION (FM)**—(1) A flux reversal at the beginning of a cell time represents a clock bit. (2) A "1" bit is a flux reversal at the center of the cell time. (3) A "0" bit is an absence of a flux reversal.

**FREQUENCY RESPONSE**—(1) The variation of sensitivity with signal frequency. (2) The frequency response of a tape is usually given in decibels relative to a referenced frequency-output level. (3) Also called amplitude/frequency response.

**GAMMA-FERRIC OXIDE**—The common magnetic constituent of magnetic tapes in a dispersion of fine, needle-like particles within the coating.

**GAP EROSION**—(1) The read or write gap increased in length and retreated below the head surface. (2) Usually due to deterioration of core material at the edges of the gap.

**GAP LOSS**—(1) The loss in output due to the finite gap length of the reproduce head. (2) The loss increases as the wavelength decreases.

**GAP WIDTH**—The dimension of the gap of a magnetic head measured in the direction perpendicular to the direction of the tape path.

**GAUSS**—The metric unit of the magnetic flux density equal to 1 Mx/CM<sup>2</sup>.

**HARD DISK**—(See disk.)

**HARD FERRITE**—A ferrite with a very low wear rate when compared with the soft metal laminations.

**HARD METAL LAMINATIONS**—(See core material, hard.)

**HARD SOLID METAL**—(see core material, hard.)

**HARMONIC DISTORTION**—A signal non-linearity with harmonics of the fundamental in the output when the input signal is sinusoidal.

**HEAD CONTAMINATION**—(See tape-to-head separation.)

**HEAD CONTOUR**—(1) The complex shape of the contacting surface of a head as a result of manufacture, head lapping, or wear. (2) The contour of a head is always changing throughout the head's life and, in many cases, is responsible for retiring the head.

**HEAD CRASH**—A term used for the damage to a hard disk caused by the physical contact made between the magnetic read/write heads and the surface of the hard-disk platter.

**HEAD STICK**—(1) A common word for a large increase in head-to-tape friction caused by (a) a stick by-product exuded by conditions due to tape age, temperature/humidity, and head-to-tape pressure, and (b) very smooth tapes coupled with large area heads. (2) See also sticktion and stick-slip.

**HEAD-TO-TAPE CONTACT**—The degree that a tape's magnetic coating approaches the surface of the record or reproduce head during normal operation.

**INTERLAYER TRANSFER**—Any loose material, such as oxide, generated by tape wear or a head-stick condition which is transferred from the oxide to the back of the tape, or from the back side to the oxide when the tape is wound on a reel.

**INTERMODULATION DISTORTION**—(1) A signal non-linearity with frequencies in the output equal to sums and differences of integral multiples of the component frequencies present in the input signal. (2) Harmonics are usually not included as part of the intermodulation distortion.

**INTERSYMBOL INTERFERENCE**—(1) An interference resulting in a phase shift of the cell playback crossover point with respect to the data clock. (2) When a recording system has limited record resolution, a flux transition being recorded will extend beyond its cell boundaries, adding or subtracting from the flux in the adjacent bit cells of symbols.

**IRON OXIDE**—(See gamma-ferric oxide.)

**LAMINATIONS**—(see core material.)

**LATERAL DIRECTION**—The direction across the width of the tape.

**LAYER-TO-LAYER ADHESION**—The tendency for adjacent layers of tape in a roll to adhere to one another.

**LAYER-TO-LAYER TRANSFER**—The magnetization of a layer of tape in a roll by the field from a nearby recorded layer, sometimes referred to as print through.

**LBE**—(See lower band edge.)

**LINEARITY**—The extent to which the magnitude of the reproduced output is directly proportional to the magnitude of the signal applied to the input of the recorder.

**LONG-TERM TAPE SPEED**—(See tape speed.)

**LONGITUDINAL CURVATURE**—Any deviation from the straightness of a length of tape.

**LOOSE DEBRIS**—Any material that is very lightly bonded to the tape or the head's top surface, removable by tape motion.

**LOWER BAND EDGE (LBE)**—The lower band edge of the recorder/reproducer response (usually at the  $-3$ -dB point).

**LUBRICANT**—(See additive.)

**MAGNETIC INSTABILITY**—(1) The property of a magnetic material that causes variations in the residual flux density of a tape to occur with temperature, time, and/or mechanical flexing. (2) A function of particle size, magnetizing field strength, and anisotropy.

**MAGNETIC MEDIA**—A base film, coated with magnetic particles held in a binder. (The magnetic particles are usually needle-like, single-domain, gamma-ferric oxide.)

**MAGNETIZING FIELD STRENGTH**—The instantaneous strength of the magnetic field applied to a sample of magnetic material.

**MFM**—(See modified frequency modulation.)

**MODIFIED FREQUENCY MODULATION (MFM)**—(1) A code that has a "1" and a "0" corresponding to the respective presence or absence of a transition in the center of the corresponding bit cell. (2) Additional transitions at the cell boundaries occur only between bit cells that contain consecutive "0" values. (3) Also called delay modulation.

**MODULATION NOISE**—(See noise.)

**NOISE**—Any unwanted electrical disturbances other than crosstalk or distortion components that occur at the output of the reproduce amplifier. (1) System noise is the total noise produced by the whole recording system, including the tape. (2) Equipment noise is produced by all the components of the system, with the exception of the tape. (3) Tape noise can be specifically ascribed to the tape. The following are typical sources of tape noise: (a) Bulk-erased noise arises when a bulk-erased tape with the erase and record heads completely deenergized is reproduced. (b) Zero-modulation noise arises when an erased tape with the erase and record heads energized as they would be in normal operation, but with zero input signal, is reproduced. This noise is usually 3 to 4 dB higher than the bulk-erased noise. The difference between bulk-erased and zero-modulation noise is sometimes termed bias-induced noise. (c) Saturation noise arises when a uniformly saturated tape is reproduced. This is often some 15 dB higher than the bulk-erased noise and is associated with imperfect particle dispersion. (d) Dc noise arises when a tape that has been non-uniformly magnetized by energizing the record head with dc, either in the presence or the absence of bias, is reproduced. This noise has pronounced, long, wavelength components that can be as much as 20 dB higher than those obtained from a bulk-erased tape. At very high values of dc, the dc noise approaches the saturation noise. Dc noise is actually the low-frequency component of modulation noise. (e) Modulation noise is essentially a modulation of the desired signal by noise that is caused by non-uniform dispersion of elementary magnetic particles in the

tape's coating material. This noise, which occurs only when a recorded tape is reproduced, increases with the intensity of the reproduced signal. Dc noise is actually the low-frequency component of modulation noise.

**NOISE PULSE**—(1) A short-duration false signal occurring during the reproduction of a tape. (2) A signal that is of a magnitude considerably in excess of the average peak value of the ordinary system noise.

**NOMINAL BIT TIME**—(1) The average bit time of recording at continuous maximum-flux reversals. (2) Also called cell time.

**NON-RETURN-TO-ZERO (NRZ0)**—The flux reversal for a "0"; no flux reversal for a "1."

**NON-RETURN-TO-ZERO INVERTED (NRZI)**—The flux reversal for a "1"; no flux reversal for a "0."

**NON-RETURN-TO-ZERO (NRZ) RECORDING**—(See digital recording.)

**OERSTED**—A unit of magnetic field strength.

**OUTPUT**—The magnitude of the reproduced signal voltage, usually measured at the output of the reproduced amplifier.

**OXIDE BUILD-UP**—The accumulation of oxide or wear products as deposits on the surface of heads and guides.

**OXIDE LOADING**—(1) A measure of the density with which oxide is packed into a coating. (2) The weight of the oxide per unit volume of the coating.

**OXIDE SHED**—The loosening of particles of oxide from the tape coating during use.

**PACKING DENSITY**—The amount of digital information recorded along the length of a tape, measured in bits per inch.

**PARTICLE ORIENTATION**—The rotation of needle-like particles so that their longest dimensions tend to lie parallel to one another.

**PARTICLE SHAPE**—The needle-like particles of gamma-ferric oxide used in conventional magnetic tape, with a dimensional ratio of about 6 to 1.

**PARTICLE SIZE**—The physical dimensions of magnetic particles used in a magnetic tape.

**PERMANENT ELONGATION**—The percentage of elongation remaining on a tape or a length of base film after a given load applied for a given time has been removed.

**PLASTICIZER**—(See additive.)

**POLYESER**—(1) An acronym for polyethylene glycol terephthalate. (2) The material most commonly used as a base film for precision magnetic tape.

**READ/WRITE ERASE HEAD**—A three-gap head (read, write, erase) on one body. Sometimes the erase head is bolted to the read/write head.

**READ/WRITE HEAD**—A two-gap head (read, write) on one body.

**REEL**—The metal-, glass-, or plastic-flanged hub on which magnetic tape is wound.

**REFERENCE TAPE**—A tape used as a reference against which the performances of other tapes are compared.

**REMANENCE**—(1) The magnetic flux density that remains in a magnetic circuit after removal of applied magnetomotive force. (2) Is not necessarily equal to residual flux density.

**REMOVABLE FIXED DISK**—A hard-disk device (usually) with only one hard-disk platter that's used to record and retrieve data.

**RESISTIVITY**—(See coating resistance.)

**RESOLUTION (DYNAMIC RANGE)**—The average peak-to-peak signal amplitude at the maximum flux reversal divided by the average peak-to-peak signal amplitude at the minimum flux reversal at the desired recording method.

**RETENTIVITY**—The maximum value of residual flux density corresponding to saturation flux density.

**RZ RECORDING**—(See digital recording.)

**SATURATION FLUX DENSITY**—(1) The maximum intrinsic flux density possible in a sample of magnetic material. (2) The intrinsic flux density asymptotically approaches the saturation flux density as the magnetizing field strength increases.

**SATURATION NOISE**—(See noise.)

**SCRATCH**—A long, narrow, straight defect in the top surface of a head track or a tape.

**SENSITIVITY**—The magnitude of the output when reproducing a tape recorded with a signal of given magnitude and frequency.

**SEPARATION LOSS**—The loss in output that occurs when the surface of the coating of a magnetic tape fails to make perfect contact with the surface of the record or reproduce head.

**SHEDDING**—The loss of oxide or other particles from the coating or backing of a tape, usually causing contamination of the tape transport and, by redeposit, of the tape itself.

**SHORT-TERM TAPE SPEED**—(See tape speed.)

**SIGNAL-TO-NOISE RATIO**—(1) The ratio of the power output of a given signal to the noise power in a given bandwidth. (2) Is usually measured by the corresponding root mean square signal and noise voltages appearing across a constant output resistance.

**SKEW**—A deviation of a line connecting the average displacement of the read or write track gaps from a line perpendicular to the reference edge of the tape in the direction of tape motion.

**SKEW TAPE**—(1) The continuous strings of "1" values written on a properly adjusted tape drive for the entire recoverable length of the tape. (2) An "all '1' pattern" on all tracks. (3) The write head, the write delays, and the tape drive adjusted to write with minimum physical skew and gap scatter.

**SOFT METAL LAMINATIONS**—(See core material, soft.)

**SPOKING**—A buckling in which the tape pack is deformed into a shape that approximates a polygon.

**SPOOL**—(See reel.)

**SQUEAL**—(See stick-slip.)

**STANDARD REFERENCE TAPE**—A tape intended for daily calibration, the performance of which has been calibrated to the amplitude reference tape.

**STATIC**—(See tape skew.)

**STICK-SLIP**—(1) A low-speed phenomenon. (2) A relationship between tension, temperature, humidity, wrap angle, head material, tape binder, and elastic properties. (3) When detected audibly, it is a squeal.

**STICKTION**—The tape's adhering to transport components, such as heads or guides.

**STIFFNESS**—(1) The resistance to bending the tape. (2) A function of tape thickness. (3) A modulus of elasticity.

**SURFACE TREATMENT**—Any process by which the surface smoothness of the tape coating is improved after it has been applied to the base film.

**SYSTEM NOISE**—(See noise.)

**TAPE CONTAMINATION**—(See tape-to-head separation.)

**TAPE NOISE**—(See noise.)

**TAPE PACK**—The form taken by the tape wound on a reel.

**TAPE SKEW**—(1) The tape's deviation from following a linear path when transported across the heads. (2) The terms static and dynamic distinguish between the physically fixed components and the fluctuating components of total tape skew.

**TAPE SPEED**—(1) The speed at which the tape is transported across the read/write head during normal recording or reproduction. (2) Long-term speed is averaged over a minimum of 15 inches of tape (in inches per second). (3) Short-term speed is the instantaneous (dynamic) tape speed (in inches per second).

**TAPE-TO-HEAD SEPARATION**—(1) Separation.—The separation between a magnetic head and the magnetic tape caused by the (a) foil-bearing effect, (b) improper head contour, which generates standing waves in the tape, and (c) surface roughness of the tape. These conditions are interrelated and are greatly influenced by tape tension and tape compliancy. In a properly designed system, tape roughness is the limit of head-to-tape separation, usually <10 fm. (2) Changes.—(a) Head contamination is the debris attached to the head, which causes the tape to lift away from the head, forming a tent-like deformation of the tape. This tent does not move or change shape until the contamination is removed. (b) Tape contamination includes particles attached to the tape, resulting in a tent that moves across the head with the tape. (3) Effective.—(a) The actual distance from the magnetic storage material on the tape to the top of the active magnetic core material at the read or write gape. (b) The effective



head-to-tape separation is usually somewhat larger than the mechanical head-to-tape separation.

**TAPE TRANSPORT**—(1) The mechanism that extracts magnetic tape from a storage device, moves it across magnetic heads at a controlled speed and then feeds it into another storage device. (2) Typical storage devices are tape loops, bins, reels, cassettes, and cartridges. (3) The tape transport is the part of a magnetic tape recorder/reproducer system that normally consists of magnetic heads, magnetic tape, transport, record electronics, and reproduce electronics.

**TEAR STRENGTH**—The force required to initiate and/or propagate a tear in a specially shaped specimen of tape or base film.

**TOTAL THICKNESS**—The sum of the thicknesses of the base film and the magnetic coating, as well as back coating, when applied. The total thickness governs the length of tape that can be wound on a given reel.

**TRACK**—An area of the tape's surface that coincides with the location of the recorded magnetization produced by one record gap.

**TRACK WIDTH**—The width of the track corresponding to a given record gap.

**UBE**—(See upper band edge.)

**UNDERCUT**—(See washout.)

**UNIFORMITY**—The extent to which the output remains free from variations in amplitude. Uniformity is usually specified as the positive and negative deviations from the average output within a roll of tape.

**UPPER BAND EDGE (UBE)**—The upper band edge of the recorder/reproducer response (usually at the  $-3\text{dB}$  point).

**VOID**—An area where material is missing on the surface of a tape or on a head's track.

**WASHOUT**—(1) A hard-coated head whose magnetic core material has a much higher wear rate than the coating. (2) The radius of curvature of the core material will be larger than the surrounding coating of the softer material, which could even be undercut, possibly causing an increase in the head-to-tape separation. (3) Also called undercut.

**WAVELENGTH**—The distance along the length of a sinusoidally recorded tape corresponding to one cycle.

**WAVINESS**—(1) A non-flat head's top surface perpendicular to the tape motion due to different wear rates in top surface materials. The harder material will be up. The head core is usually the harder material; therefore, there will be increased head-to-tape contact pressure at the cost of tape life. (2) Can occur during break-in or field use.

**WEAR ABILITY**—(See durability.)

**WEAR PRODUCT**—Any material that is detached from the tape during use.

**WEAR TEST**—(See durability.)

**WIND**—The way in which tape is wound onto a reel. An A-wind is one in which the tape is wound so that the coated surface faces toward the hub.

**WINDER/CLEANER**—A device that winds and cleans magnetic tape to restore it to a near-new condition, providing the tape has not been physically damaged.

**WOW AND FLUTTER**—(1) The changes in signal-output frequency caused by tape-speed variations occurring at relatively low and relative high rates, respectively. (2) Wow is no longer used, but is incorporated into the flutter measurement.

**WRITE FEEDTHROUGH**—(1) The magnetic coupling from the write track to a read track in the read/write head. (2) Also called crossfeed and crosstalk.

**ZERO-MODULATION NOISE**—(See noise.)

## APPENDIX II

# REFERENCES

- Magnetic Tape Recording Technical Fundamentals*, Datatape Incorporated, 360 Sierra Madre Villa, Pasadena, CA, 1986.
- Parallel Mode High Density Digital Recording Technical Fundamentals*, Datatape Incorporated, 360 Sierra Madre Villa, Pasadena, CA, 1976.
- Aviation ASW Technician 3&2*, NAVEDTRA 10353-D, Naval Education and Training Professional Development and Technology Center, Pensacola, FL, 1987.
- Haynes, N. M., *Transistor Circuits for Magnetic Recording*, Howard W. Sams & Co., Indianapolis, IN, January 1964.
- Magnetic Tape Recording for the Eighties*, NASA Reference Publication 1075, Goddard Space Flight Center, Green Belt, MD, 1982.
- Data Systems Technician 3&2*, Vol. 2, NAVEDTRA 10231, Naval Education and Training Professional Development and Technology Center, Pensacola, FL, 1987.
- AN/TNH-21 *Recorder-Reproducer Set, Sound, Instruction Manual*, National Security Agency, Fort G. Meade, MA, December 1973.
- NSA Technical Support Manual, Magnetic Tape Recording*, National Security Agency, Washington DC, 1957.
- System Description Manual for Recorder-Reproducer Set, Signal Data*, AN/USH-23(V), NAVELEX 0967-LP-546-1010, Naval Electronics Systems Command, Washington, DC, 1975.
- Operation and Maintenance Instructions for Model 100X Magnetic Tape Recorder*, NAVELEX 0967-LP-551-3010, Naval Electronics Systems Command, Washington, DC, 1976.
- Recorder-Reproducer Set, Magnetic Disk AN/UYH-3(V), Operation and Maintenance Instructions*, NAVSEA SE600-AA-MMM-010/AN/UYH-3(V), Naval Sea Systems Command, Washington, DC, 1982.
- Input/Output Interfaces, Standard Digital Data, Navy Systems*, MIL-STD-1397A(NAVY), Naval Sea Systems Command, Washington, DC, 1983.
- Technical Manual, Operation Instructions, Maintenance Instructions, Parts List, Installation Instructions, Recorder-Reproducer Set, Signal Data*, USH-26(V), NAVSEA SE640-AF-MMO-010/USH-26(V), Naval Sea Systems Command, Washington, DC, 1981.
- Operating Instructions and Organizational Maintenance Instructions*, Chap. 1, *Signal Data Recorder-Reproducer Set*, AN/USH-24(V), 521600 and 521600-0001, SPAWAR 0967-LP-590-0010, Space and Naval Warfare Systems Command, Washington, DC, 1979.
- Data Processing Technician Third Class*, NAVEDTRA 10263, Naval Education and Training Professional Development and Technology Center, Pensacola, FL, 1987.



# MODULE 23 INDEX

## A

- Access time, magnetic disk recording, 8-20
- Actuator arm assembly, 8-13 to 8-15
  - floppy disk drive transports, 8-12
  - hard disk drive transports, 8-14
- Analog magnetic recording tape, 2-2
- Automatic tape degausser, 2-11

## B

- Bi-phase level encoding, 7-7

## C

- Capstan speed control, 4-11
  - capstan motor drive circuit, 4-13
  - capstan speed monitor, 4-12
  - comparison network, 4-13
  - precision frequency source, 4-11
  - speed correction circuit, 4-13
  - speed select network, 4-12
- Cleaning magnetic tape recorder heads, 3-5
- Closed-loop capstan drive, 4-8 to 4-10
  - differential velocity capstans, 4-9
  - dual-motors dual capstan, 4-9
  - peripheral drive capstans, 4-10
- Co-axial tape reeling configuration, 4-6 to 4-7
- Computer-compatible digital tape recorders, 7-7
- Construction of magnetic tape recorder heads, 3-2 to 3-4
- Control electronics, magnetic disk drive, 8-17
- Co-planar tape reeling configuration, 4-6

## D

- Definitions, digital magnetic tape recording, 7-3
- Degaussers, magnetic tape, 2-11
  - automatic tape degausser, 2-11
  - manual tape degausser, 2-11
- Degaussing magnetic tape, 2-10 to 2-12
- Demagnetizing magnetic tape recorder heads, 3-5 to 3-7

- Demagnetizing magnetic tape recorder transports, 4-14
- Differential velocity capstans, 4-9
- Digital data, recording, 8-10 to 8-12
  - frequency modulation (FM) encoding, 8-10 to 8-11
  - modified frequency-modulation (MFM) encoding, 8-10
  - run-length-limited (RLL) encoding, 8-12
- Digital magnetic recording tape, 2-2 to 2-3
- Digital magnetic tape recording, 7-1 to 7-8
  - computer-compatible digital tape recorders, 7-7
  - definitions, 7-3
  - encoding methods, 7-4 to 7-7
  - formats, 7-1 to 7-3
  - instrumentation magnetic tape recorders, 7-8
  - introduction to, 7-1
  - parallel digital magnetic tape recording format, 7-2
  - serial digital magnetic tape recording format, 7-2
  - serial-parallel digital magnetic tape recording format, 7-3
  - telemetry digital tape recorders, 7-7
- Direct record electronics, 5-1 to 5-2
- Direct reproduce electronics, 5-2 to 5-3
- Diskettes, flexible magnetic recording, 8-2 to 8-5
- Disks, fixed magnetic recording, 8-6 to 8-9
- Drive electronics circuit board, 8-13
  - floppy disk drive transports, 8-12 to 8-13
  - hard disk drive transports, 8-14 to 8-15
- Drive motor/spindle assembly, 8-13
  - floppy disk drive transports, 8-12
  - hard disk drive transports, 8-14
- Dropout errors, magnetic tape, 2-3
- Dual-motors dual capstan, 4-9 to 4-10

## E

- Electronics, 5-1 to 5-5, 8-17 to 8-18
  - direct record, 5-1 to 5-2

Electronics—Continued  
 direct reproduce, 5-2 to 5-3  
 frequency modulation (FM) record, 5-3 to 5-4  
 frequency modulation (FM) reproduce, 5-4 to 5-5  
 magnetic disk drive, control electronics, 8-17  
 magnetic disk drive, interface electronics, 8-18 to 8-20  
 magnetic disk drive, write/read electronics, 8-18

Encoding methods, digital magnetic tape recording, 7-4 to 7-7  
 bi-phase level encoding, 7-7  
 Non-Return-to-Zero (NRZ) encoding, 7-6  
 return-to-Bias (RB) encoding, 7-4  
 return-to-Zero (RZ) encoding, 7-5

Encoding methods, frequency modulation (FM), 8-10 to 8-11

Encoding methods, modified frequency-modulation (MFM), 8-11

Encoding methods, run-length-limited (RLL), 8-12

Enhanced Non-Return-to-Zero-Level (E-NRZ-L) encoding, 7-6

Enhanced small device interface (ESDI), 8-19

Erase heads, 3-4

Erasing, floppy disk, 8-5

Erasing, hard disk, 8-9 to 8-10

Erasing magnetic tape, 2-10 to 2-11

## F

Fixed magnetic recording disks, 8-6  
 hard disk construction, 8-6  
 hard disk data organization, 8-7  
 hard disk erasing, 8-9 to 8-10  
 hard disk handling, storage, and shipping, 8-8 to 8-9

Flexible magnetic recording diskettes, 8-2 to 8-5

Floppy disk construction, 8-2 to 8-4

Floppy disk data organization, 8-3 to 8-4

Floppy disk drive preventive maintenance, 8-16

Floppy disk drive transports, 8-12 to 8-13

Floppy disk drive transports—Continued  
 actuator arm assembly, 8-13  
 drive electronics circuit board, 8-13  
 drive motor/spindle assembly, 8-13  
 head arm assembly, 8-13

Floppy disk erasing, 8-5

Floppy disk handling, storage, and shipping, 8-4 to 8-5

Flutter, 6-8 to 6-10

Formats, digital magnetic tape recording, 7-1 to 7-3

Frequency modulation (FM) encoding, 8-10 to 8-11

Frequency modulation (FM) record electronics, 5-3 to 5-4

Frequency modulation (FM) reproduce electronics, 5-4 to 5-5

Frequency response, 6-3 to 6-5

## H

Hard disk construction, 8-6

Hard disk drive preventive maintenance, 8-17

Hard disk drive transports, 8-14 to 8-15  
 actuator arm assembly, 8-15  
 drive electronics circuit board, 8-15  
 drive motor/spindle assembly, 8-14  
 head arm assembly, 8-15

Hard disk erasing, 8-9 to 8-10

Hard disk handling, storage, and shipping, 8-8 to 8-9

Harmonic distortion, 6-5

Head arm assembly, floppy disk drive transports, 8-13

Head arm assembly, hard disk drive transports, 8-15

Head-to-tape sticking, 2-5

Heads, erase, magnetic tape recorder, 3-4

Heads, magnetic tape recorder, 3-1 to 3-9

## I

Instrumentation magnetic tape recorders, 7-8

Integrated drive electronics (IDE), 8-20

Interface electronics, magnetic disk drive, 8-18 to 8-20

Interface electronics, magnetic disk drive—  
Continued  
    enhanced small device interface (ESDI),  
        8-19  
    integrated drive electronics (IDE), 8-20  
    Naval tactical data system (NTDS)  
        interface, 8-18  
    small computer systems interface (SCSI),  
        8-19  
    ST-506/412 interface, 8-18 to 8-19  
Interleave factor, magnetic disk recording,  
    8-20 to 8-21

## L

Latency period, magnetic disk recording, 8-20  
Layer-to-layer adhesion, 2-5  
Level errors, magnetic tape, 2-4

## M

Magnetic disk drive electronics, 8-17 to 8-20  
Magnetic disk drive transports, 8-12 to 8-15  
    floppy disk drive transports, 8-12 to 8-13  
    hard disk drive transports, 8-14 to 8-15  
Magnetic disk recording, 8-1 to 8-25  
    fixed magnetic recording disks, 8-6 to  
        8-9  
    flexible magnetic recording diskettes, 8-2  
        to 8-5  
    recording digital data, 8-10 to 8-12  
    run length-limited (RLL) encoding, 8-12  
    specifications, 8-20 to 8-21  
Magnetic heads, 1-5  
Magnetic recorders, history of, 1-2 to 1-4  
    input signal, 1-5  
    magnetic heads, 1-5  
    prerequisites for, 1-5 to 1-6  
    recording medium, 1-5  
Magnetic tape, 2-1 to 2-15  
    analog, 2-2  
    base material, 2-2  
    causes of failure, 2-4 to 2-8  
    digital, 2-2  
    dropout errors, 2-3  
    erasing and degaussing, 2-10 to 2-12  
    glue, 2-2

Magnetic tape—Continued  
    handling, 2-12 to 2-13  
    level errors, 2-4  
    noise errors, 2-3  
    oxide coating, 2-2  
    packaging for shipping, 2-14  
    skew errors, 2-3 to 2-4  
    storing, 2-13  
    tape reels and tape cartridges, 2-9 to 2-10  
Magnetic tape failure, causes of, 2-4  
    accidental damage, 2-5  
    causes of, layer-to-layer adhesion, 2-5  
    cinching, 2-6 to 2-7  
    dirt build-up, 2-6  
    environmental damage, 2-5 to 2-6  
    excessive tape and head wear, 2-6  
    head-to-tape sticking, 2-5  
    normal wear, 2-4  
    oxide shedding, 2-5  
    pack slip, 2-7  
    spoking, 2-8  
    tape deformation, 2-5  
    winding errors, 2-6 to 2-9  
    windowing, 2-8  
Magnetic tape recorder heads, 3-1 to 3-9  
    cleaning, 3-5  
    construction of, 3-2 to 3-4  
    demagnetizing, 3-5  
    erase heads, 3-4  
    record and reproduce heads, 3-3 to 3-4  
Magnetic tape recorder record and reproduce  
    electronics, 5-1 to 5-6  
    direct record electronics, 5-1 to 5-2  
    direct reproduce electronics, 5-2 to 5-3  
    FM record electronics, 5-3 to 5-4  
    FM reproduce electronics, 5-4 to 5-5  
Magnetic tape recorder transports, 4-1 to 4-16  
    capstan speed control, 4-11 to 4-13  
    cleaning, 4-13 to 4-14  
    closed-loop capstan drive, 4-8 to 4-10  
    demagnetizing, 4-14 to 4-15  
    open-loop capstan drive, 4-7 to 4-8  
    tape reeling systems, 4-2 to 4-7  
    tape transport configurations, 4-7 to 4-10  
Magnetic tape recording specifications, 6-1 to  
    6-14

Magnetic tape recording specifications—  
Continued

- flutter, 6-9 to 6-10
- frequency response, 6-3 to 6-5
- harmonic distortion, 6-5 to 6-7
- phase response, 6-7 to 6-9
- signal-to-noise ratio, 6-2 to 6-3
- skew, 6-11 to 6-13
- time-base error, 6-10 to 6-11

Maintenance, floppy disk drive, 8-16

Maintenance, hard disk drive, 8-17

Manual tape degausser, 2-11 to 2-12

Modified frequency-modulation (MFM)  
encoding, 8-11

**N**

Naval Tactical Data System (NTDS)  
interface, 8-18

Noise errors, magnetic tape, 2-3

Non-Return-to-Zero (NRZ) encoding, 7-5

Non-Return-to-Zero-Level (NRZ-L)  
encoding, 7-6

Non-Return-to-Zero-Mark (NRZ-M)  
encoding, 7-6 to 7-7

Non-Return-to-Zero-Space (NRZ-S)  
encoding, 7-7

**O**

Open-loop capstan drive, 4-7 to 4-8

Oxide shedding, 2-5

**P**

Packaging magnetic tape for shipping, 2-14

Parallel digital magnetic tape recording  
format, 7-2

Peripheral drive capstans, 4-10

Phase response, 6-7 to 6-9

Physical properties of magnetic tape, 2-1 to  
2-2

- base material, 2-2

- glue, 2-2

- oxide coating, 2-2

Precision frequency source, 4-11

**R**

Record and reproduce heads, 3-3

Recording density, magnetic disk recording,  
8-21

Recording medium, 1-5

References, AII-1 to AII-2

Return-to-Bias (RB) encoding, 7-4

Return-to-Zero (RZ) encoding, 7-4

Run-length-limited (RLL) encoding, 8-12

**S**

Seek time, magnetic disk recording, 8-20

Serial digital magnetic tape recording format,  
7-2

Serial-parallel digital magnetic tape recording  
format, 7-3

Signal-to-noise ratio, 6-2 to 6-3

Skew, 6-11 to 6-13

Skew errors, magnetic tape, 2-3 to 2-4

Small computer systems interface (SCSI),  
8-19

Speed correction circuit, 4-13

Speed select network, 4-12

ST-506/412 interface, 8-18 to 8-19

Storing magnetic tape, 2-13

**T**

Take-up control reeling systems, 4-2

Tape buffering reeling systems, 4-3 to 4-4

Tape deformation, 2-5

Tape reeling systems, 4-2 to 4-7

- configurations, 4-6

- take-up control reeling systems, 4-2

- tape buffering reeling systems, 4-3 to 4-4

- tape guides, 4-4 to 4-5

- two-motor reeling systems, 4-2

Tape reels and tape cartridges, 2-9 to 2-10

Tape transport configurations, 4-7 to 4-11

- closed-loop capstan drive, 4-8 to 4-11

- open-loop capstan drive, 4-7 to 4-8

Telemetry digital tape recorders, 7-7

Time-base error, 6-10 to 6-11



Transfer rate, magnetic disk recording, 8-21  
Transports, 8-12 to 8-15  
    magnetic disk drive, 8-12 to 8-13  
Two-motor reeling systems, 4-2

## **W**

Write/read electronics, magnetic disk drive,  
    8-18



---

---

# *Assignment Questions*

---

---

**Information:** The text pages that you are to study are provided at the beginning of the assignment questions.



## ASSIGNMENT 1

Textbook assignment: Chapter 1, "Introduction to Magnetic Recording," pages 1-1 through 1-7. Chapter 2, "Magnetic Tape," pages 2-1 through 2-158. Chapter 3, "Magnetic Tape Recorder Heads," pages 3-1 through 3-9. Chapter 4 "Magnetic Tape Recorder Transports," pages 4-1 through 4-17.

---

- 1-1. In what year did Oberlin Smith originate the idea of using permanent magnetic impressions to record sound?
1. 1880
  2. 1888
  3. 1900
  4. 1908
- 1-2. In 1925, magnetic recording began receiving attention when what device was invented?
1. Magnetic tape
  2. Magnetic disk
  3. Electronic amplifiers
  4. Video recorders
- 1-3. In 1907, Mr. Poulsen discovered dc bias. How did adding dc bias to the input signal solve the distortion problem for magnetic recording?
1. It moved the input signal away from the step in the magnetism curve
  2. It moved the input signal directly onto the step in the magnetism curve
  3. It moved the output signal directly over the step in the magnetism curve
  4. It straightened the step in the magnetism curve
- 1-4. After 1925, the Naval Research Laboratory greatly improved the signal-to-noise ratio of magnetic recording by adding what component?
1. Ac bias
  2. Electronic amplifiers
  3. Transistors
  4. Dc motors
- 1-5. In what year was plastic based tape introduced?
1. 1900
  2. 1925
  3. 1939
  4. 1947
- 1-6. In 1956, IBM introduced what major contribution to magnetic recording?
1. The magnetic tape drive
  2. The floppy disk drive
  3. The hard disk drive
  4. Each of the above
- 1-7. In 1966, IBM introduced the first removable-pack hard disk drive.
1. True
  2. False
- 1-8. In what year was the 5 1/4" floppy disk drive invented?
1. 1956
  2. 1976
  3. 1980
  4. 1988
- 1-9. Which of the following is a prerequisite for magnetic recording?
1. An input signal
  2. A recording medium
  3. A magnetic head
  4. Each of the above

- 1-10. A magnetic recording medium is any material that has the ability to become magnetized, in set amounts, in large sections along its entire length.
1. True
  2. False
- 1-11. Magnetic heads are transducers that convert the electrical variations of your input signal into what type of variations that are stored on a recording medium?
1. Magnetic
  2. Electrical
  3. Electrical and magnetic combined
  4. Direct current
- 1-12. What factor determines the number of turns of wire placed on the core of a magnetic head?
1. The size of the magnetic head
  2. The size of the head-gap
  3. The purpose of the magnetic head
  4. Each of the above
- 1-13. All magnetic heads operate the same way. An electric current passes through the coil. Magnetic field lines associated with the electric current follow paths through the core material. When the magnetic field lines get to the head-gap, some of them spread outside the core to form a fringing field. When a recording medium is passed through this fringing field, magnetic recording happens.
1. True
  2. False
- 1-14. Which of the following materials is used to make magnetic tape?
1. Base material
  2. Magnetic oxide coating
  3. Glue
  4. Each of the above
- 1-15. The base material of magnetic tape is made with what material?
1. Plastic
  2. Metal
  3. Either 1 or 2
  4. Paper
- 1-16. Which of the following can happen if the magnetic particles used to make magnetic tape aren't uniform in size?
1. The tape's surface will be abrasive which reduces the magnetic head's life
  2. The frequency response of the tape will be distorted
  3. The glue will not hold the particles in place
  4. The oxide coating cannot be magnetized
- 1-17. Generally, short magnetic oxide particles are used on magnetic tape to record low-frequency signals and long particles are used to record high-frequency signals.
1. True
  2. False
- 1-18. Why does digital magnetic tape use a base material about 50 percent thicker than analog magnetic tape?
1. Thicker tape is needed to hold the long magnetic oxide particles
  2. Thicker tape allows the tape to withstand the more strenuous starts and stops
  3. Thicker tape is needed for instrumentation type signals
  4. Thicker tape can store more digital data

- 1-19. There are four types of tape errors that can degrade the performance of a magnetic recording system. Which of the following tape errors is the most common and causes a 50% or more drop in signal strength?
1. Noise
  2. Skew
  3. Signal dropout
  4. Level
- 1-20. Which of the following contaminants can cause signal dropouts?
1. Dust
  2. Lint
  3. Oil
  4. Each of the above
- 1-21. Which of the following items on magnetic tape will cause noise errors?
1. Dust or lint
  2. A cut
  3. A scratch
  4. Both 2 and 3 above
- 1-22. Brand "X" magnetic tape is rated for 5 volts ( $\pm 10\%$ ). Which of the following minimum and maximum voltage levels is what the output signal level could vary before it is considered a level error?
1. 4.95/5.05
  2. 4.75/5.25
  3. 4.5/5.5
  4. 4/6
- 1-23. Magnetic tape can eventually become unusable when it comes in contact with the fixed surfaces of a recorder over long periods of time. What causes this type of tape failure?
1. Environmental damage
  2. Normal wear
  3. Winding errors
  4. Accidental damage
- 1-24. Ideally, magnetic tape should be used and stored within what temperature and humidity range?
1. 40 - 80° F, 60 - 80% humidity
  2. 50 - 70° F, 60 - 80% humidity
  3. 60 - 80° F, 60 - 80% humidity
  4. 60 - 80° F, 40 - 60% humidity
- 1-25. Using magnetic tape in a workplace that exceeds the ideal temperature and humidity ranges can cause which of the following types of environmental damage to the tape?
1. Dirt build-up
  2. Layer-to-layer sticking
  3. Tape deformation
  4. Each of the above
- 1-26. At temperatures above 130 degrees, what happens to a tape's oxide coating?
1. Becomes soft
  2. Separates from the base material
  3. Both 1 and 2 above
  4. Becomes brittle
- 1-27. What causes head-to-tape sticking?
1. Temperatures below 2° F
  2. Dirty record/reproduce heads
  3. The tape binder glue softens
  4. Static electricity
- 1-28. Which of the following environmental conditions could create static electricity which attracts dirt build-up on the tape and tape recorder parts?
1. Relative humidity of 5%
  2. Temperature of 28° F
  3. Relative humidity of 96%
  4. Temperature of 135° F

- 1-29. Excessive tape and head wear caused by increased friction as the tape passes over the heads can happen if the relative humidity is more than what maximum percent?
1. 70%
  2. 85%
  3. 95%
  4. 90%
- 1-30. Winding errors can happen when improper winding practices create an excessive or uneven force as the tape is being wound onto a tape reel.
1. True
  2. False
- 1-31. When winding a tape onto a reel, you notice that a sudden stop causes the outer layers of the tape to continue to spin after the inner layers have stopped. What type of deformed tape pack does this cause?
1. Pack-slip
  2. Cinching
  3. Spoking
  4. Windowing
- 1-32. The magnetic tape on your reel is unwinding unevenly and rubbing against the sides of the reel and the recorder's tape guides. What type of deformed tape pack could cause this condition?
1. Spoking
  2. Windowing
  3. Pack-slip
  4. Skewing
- 1-33. You notice a spoked tape pack on the take-up reel of your recorder. What causes a spoked tape pack?
1. Tape is wound over a small particle on the reel hub
  2. A distorted reel hub creates uneven pressures as the tape is wound onto the reel
  3. Tape is wound with increasing tension toward the end of the winding
  4. Each of the above
- 1-34. Which of the following tape pack deformities is an example of windowing?
1. The inner part of the tape pack is buckled and deformed
  2. The tape pack contains steps caused by the tape shifting from side to side during winding
  3. The tape pack contains voids or see-through air gaps
  4. Each of the above
- 1-35. Which of the following materials can be used to make tape reels?
1. Plastic
  2. Metal
  3. Glass
  4. Each of the above
- 1-36. The flanges of a magnetic tape reel are designed to guide the magnetic tape onto the reel.
1. True
  2. False
- 1-37. Magnetic tape is erased by exposing it to what type of magnetic field?
1. A gradually decreasing dc field
  2. A gradually increasing dc field
  3. A gradually decreasing ac field
  4. A gradually increasing ac field



- 1-38. Which of the following is a disadvantage of using a tape recorder's erase head to erase magnetic tape?
1. It causes a distorted tape pack
  2. It's slow
  3. It may not do a complete erasure
  4. Both 2 and 3 above
- 1-39. Both manual and automatic tape degaussers use the same electronic principles for erasing magnetic tape.
1. True
  2. False
- 1-40. Which of the following is NOT an appropriate place to keep a magnetic tape reel or cartridge?
1. Mounted on a magnetic tape recorder
  2. Stored in a plastic bag
  3. Laying on top of a magnetic tape recorder
  4. Both 2 and 3 above
- 1-41. Which of the following is a CORRECT method for handling magnetic tape?
1. Never let any part of the tape, except the end, trail on the floor
  2. Always hold a tape reel by the flanges
  3. Never handle or touch a tape's working surface
  4. Each of the above
- 1-42. Which of the following is a CORRECT method for storing magnetic tape?
1. Always store tape reels laying on their sides, never vertically
  2. Store tapes away from equipment that generates stray magnetic fields
  3. Keep the storage area at 40 to 80% relative humidity
  4. All of the above
- 1-43. Which of the following is a CORRECT method for packaging magnetic tape for shipping?
1. Always use reel bands where available
  2. Always package reels supported by their hubs and in a vertical position
  3. Always package cartridges in their shipping cases
  4. Each of the above
- 1-44. What parts of a magnetic tape recorder are considered the heart of magnetic tape recording?
1. Magnetic tape reel
  2. Magnetic heads
  3. Transport electronics
  4. Operator control panel
- 1-45. The heads of a magnetic tape recorder perform what part of the overall tape recording process?
1. Record signal or data onto magnetic tape
  2. Reproduce signal or data from magnetic tape
  3. Erase signal or data from magnetic tape
  4. Each of the above
- 1-46. All magnetic heads are made using a plastic core wrapped with a few turns of very thin wire.
1. True
  2. False
- 1-47. What specification of a magnetic head determines the maximum frequency the head will be able to transfer onto and off of the magnetic tape?
1. Headgap
  2. Size of the core
  3. Number of turns of wire on the core
  4. Each of the above

1-48. What is the only physical difference between a record head and a reproduce head?

1. Number of turns of wire on the core
2. Size of the core material
3. Type of core material used
4. Each of the above

1-49. A certain magnetic recorder has a maximum recording frequency response of 500 kHz. Which of the following frequencies would be a good frequency to use as an erase signal?

1. 500 kHz
2. 1200 kHz
3. 1900 kHz
4. Either 2 or 3

1-50. If you do NOT regularly clean a recorder's magnetic heads, what is the probable consequence?

1. Dirt, dust, lint, etc. will collect on the heads
2. Signal dropout errors will occur
3. Both 1 and 2 above
4. The tape pack will become skewed

1-51. What materials should you use to clean magnetic heads?

1. A bristled brush and non-detergent cleaner
2. A cotton-tipped applicator soaked in isopropyl alcohol
3. A cotton-tipped applicator soaked in a magnetic head cleaner recommended by the manufacturer
4. Either 2 or 3 above

1-52. Magnetic heads can become magnetized from many sources. Which of the following sources, if any, could magnetize a magnetic head?

1. Stray magnetic fields
2. Excessive humidity
3. Poor quality magnetic tape
4. None of the above

1-53. Magnetic head degaussers generate a strong ac magnetic field that dc-magnetizes the metal parts of a magnetic head.

1. True
2. False

1-54. Which of the following is NOT a procedure for demagnetizing magnetic heads?

1. Remove the tape reel or cartridge from the recorder
2. Touch the energized degausser to the head
3. Move the degausser back and forth across the head for 15 to 30 seconds
4. De-energize the degausser when it's an arms length away

1-55. Which of the following is a function of magnetic tape transports?

1. Moves the magnetic tape across the magnetic heads
2. Holds the moving tape
3. Protects the moving tape
4. Each of the above

---

IN ANSWERING QUESTIONS 1-56 THROUGH 1-59, SELECT THE DESCRIPTION IN COLUMN B THAT BEST DESCRIBES THE MAGNETIC TAPE RECORDER TRANSPORT PART LISTED IN COLUMN A.

1-56. Tape reeling system

1-57. Tape speed control system

1-58. Electronic sub-system

1-59. Basic enclosure

1. Monitors and controls the movement of magnetic tape

2. Holds and protects the reels or cartridges of magnetic tape

3. Activates the reeling device to move the magnetic tape

4. Physically moves the magnetic tape across the magnetic heads

---

- 1-60. What type of tape reeling system uses a "free-spooling" supply reel and a motorized take-up reel?
1. Take-up control
  2. Two-motor reeling
  3. Tape buffering
  4. Both 2 and 3 above
- 1-61. What type of tape reeling system was invented to overcome the problems of uneven tape tension and stretched tape?
1. Take-up control
  2. Two-motor reeling
  3. Tape buffering
  4. Both 2 and 3 above
- 1-62. Magnetic tape reeling systems that use the spring tension method of tape buffering use what type of device to sense changes in tape tension?
1. Vacuum air column
  2. Electro-mechanical
  3. Photo-sensitive
  4. Variable-static-sensor
- 1-63. What are the two types of tape guides used on magnetic tape reeling systems?
1. Variable and stable
  2. Round and square
  3. Single and dual
  4. Fixed and rotary
- 1-64. A co-axial tape reeling configuration places the supply and take-up reels side by side.
1. True
  2. False
- 1-65. In which of the following types of tape transport capstan drive configurations is the tape tension and head-to-tape contact most likely to vary?
1. Dual-motor dual capstan drive
  2. Peripheral drive capstan
  3. Open-loop capstan drive
  4. Closed-loop capstan drive
- 1-66. Which of the following closed-loop capstan drive tape transports will NOT work in reverse?
1. Differential velocity capstan
  2. Peripheral drive capstan
  3. Both 1 and 2 above
  4. Dual-motors dual capstan
- 1-67. What type of capstan drive tape transport moves the magnetic tape by placing the capstan directly against the tape reel or tape pack?
1. Open-loop capstan drive
  2. Peripheral drive capstan
  3. Dual-motors dual capstan
  4. Differential velocity capstan
- 1-68. Capstan speed control is a very important function of the magnetic tape transport system. Which of the following is NOT one of the six parts of a capstan speed control?
1. Capstan speed monitor
  2. Speed select network
  3. Comparison network
  4. Reel motor drive circuit
- 1-69. What part of the capstan speed control function normally uses a photo-optical tachometer attached to the shaft of the capstan motor?
1. Precision frequency source
  2. Speed select circuit
  3. Capstan speed monitor
  4. Comparison network

- 1-70. On some recorders, a servo control from tape signal is supplied to the comparison network of the capstan speed control function. What is the purpose of this signal?
1. Speeds up or slows down the capstan motor
  2. Compensates for capstan speed differences when a recorded tape is played back on a different recorder
  3. Monitors the true capstan motor speed
  4. Provides a reference frequency that the speed select network uses to drive the capstan motor
- 1-71. Which of the following items can be used to clean most magnetic tape transports?
1. Isopropyl alcohol
  2. Cotton swabs
  3. Lint-free cloths
  4. Each of the above

- 1-72. Which of the following is NOT a correct procedure for cleaning a magnetic tape transport?
1. When available, always use cotton swabs vice lint-free cloths
  2. Apply the cleaner onto the cotton swab or lint-free cloth
  3. Clean the flanged parts of the tape guides
  4. While cleaning, switch swabs and cloths often
- 1-73. Magnetic tape transports should be demagnetized periodically. To do this, use a hand-held degausser and follow the procedures for demagnetizing magnetic heads.
1. True
  2. False

## ASSIGNMENT 2

Textbook assignment: Chapter 5, "Magnetic Tape Recorder Record and Reproduce Electronics," pages 5-1 through 5-6. Chapter 6, "Magnetic Tape Recording Specifications," pages 6-1 through 6-15. Chapter 7, "Digital Magnetic Tape Recording," pages 7-1 through 7-9. Chapter 8 "Magnetic Disk Recording," pages 8-1 through 8-25.

---

- 2-1. Magnetic tape recorders use what type of electronic circuits to record and reproduce analog input signals?
1. Continuous wave
  2. Frequency modulation
  3. Amplitude modulation
  4. Both 2 and 3 above
- 2-2. Direct record electronics record input signals onto magnetic tape just as they appeared at the recorder's input.
1. True
  2. False
- 2-3. Which part of the direct record electronics component takes the input signal and the bias signal and mixes them together?
1. Input pre-amplifier circuit
  2. Bias source
  3. Summing network
  4. Head driver circuit
- 2-4. Which part of the direct record electronics amplifies the signal from the summing network and sends it to the record head?
1. Bias source circuit
  2. Head driver circuit
  3. Input pre-amplifier circuit
  4. Low-pass filter circuit
- 2-5. The pre-amplifier circuit of the direct reproduce electronics does which of the following functions?
1. Amplifies the reproduced signal
  2. Removes the bias signal
  3. Both 1 and 2 above
  4. Corrects phase errors
- 2-6. What circuit in the direct reproduce electronics takes the pre-amplified signal and fixes frequency response problems the reproduce magnetic head may have caused?
1. Equalization and phase correction circuit
  2. Output amplifier circuit
  3. Head driver circuit
  4. Summing network
- 2-7. What circuit of the direct reproduce electronics serves as an impedance matcher?
1. Pre-amplifier circuit
  2. Output amplifier circuit
  3. Equalization and phase correction circuit
  4. Head driver circuit

2-8. How do FM record electronics process the incoming signal before sending it to the record head?

1. A high frequency, negative bias is added to the input signal
2. A summing network mixes the bias and input signal
3. Both 1 and 2 above
4. The input signal is frequency modulated onto the carrier frequency of a record oscillator

2-9. In the FM record electronics, what is the output of the record oscillator circuit?

1. The demodulated input signal
2. The frequency modulated carrier signal
3. A clean input signal with the negative bias removed
4. A combined input signal and equalization signal

THIS SPACE LEFT BLANK INTENTIONALLY.

---

IN ANSWERING QUESTIONS 2-10 THROUGH 2-13, SELECT THE DESCRIPTION IN COLUMN B THAT BEST DESCRIBES THE PART OF FM REPRODUCE ELECTRONICS LISTED IN COLUMN A.

- |                                   |  |
|-----------------------------------|--|
| 2-10. Pre-amplifier circuit       | 1. Takes the signal from the limiter/demodulator and cleans-up any noise or left over carrier signal |
| 2-11. Limiter/demodulator circuit | 2. Takes the output from the low-pass filter and amplifies it for output                             |
| 2-12. Low-pass filter circuit     | 3. Takes the reproduce signal from the magnetic head and amplifies it                                |
| 2-13. Output amplifier            | 4. Stabilizes the amplitude level and demodulates the signal intelligence from the carrier signal    |
- 

2-14. Which of the following generates the noise part of a recorder's SNR?

1. Magnetic heads
2. Magnetic tape
3. Both 1 and 2 above
4. Nearby equipment

2-15. The SNR can be stated in three different ways. Which of the following is NOT one of these ways?

1. Mean signal to RMS noise
2. Peak-to-peak signal to RMS noise
3. RMS signal to RMS noise
4. Peak signal-to-RMS noise

- 2-16. Which of the following data should be included with all SNR specifications?
1. Record level
  2. Reproduce level
  3. Bandwidth
  4. Tape speed
- 2-17. What is the magnetic tape recording specification which gives a recorder's amplitude variation with frequency over a specified bandwidth?
1. Record level
  2. Frequency response
  3. Bandwidth
  4. Both 2 and 3 above
- 2-18. Your LPO tells you to test the frequency response of a particular magnetic tape recorder. You use a signal generator to sweep through the frequencies as you monitor the recorder's output amplitude on a VTVM. Which of the following readings in output amplitude would indicate the upper and lower end of the recorder's bandwidth?
1.  $\pm 2$ -dB
  2.  $\pm 3$ -dB
  3.  $\pm 5$ -dB
  4.  $\pm 10$ -dB
- 2-19. Which of the following factors can limit or degrade the frequency response of a magnetic tape recorder?
1. The record head
  2. The reproduce head
  3. Magnetic head-to-tape contact
  4. Each of the above
- 2-20. If the frequencies of the harmonic distortion are 2, 4, and 6 times the center frequency, what type of harmonic distortion is this?
1. Linear
  2. Spatial
  3. Even-order
  4. Center frequency
- 2-21. Which of the following is a cause of even-order harmonics during magnetic tape recording?
1. Defective magnetic tape
  2. Frequency response too low
  3. Permanently magnetized heads
  4. Each of the above
- 2-22. If you increase a magnetic tape recorder's signal bias level, what happens to the harmonic distortion?
1. Increases
  2. Remains the same
  3. Decreases
  4. Increases odd-order harmonic distortion
- 2-23. When measuring the amount of harmonic distortion in a magnetic tape recorder, what electronic test equipment should you use?
1. Wave analyzer
  2. VTVM
  3. Spectrum analyzer
  4. All of the above
- 2-24. When measuring harmonic distortion, you set the signal generator to input a 12-kHz test signal. At the recorder's output, what will be the frequency of the third-order harmonic?
1. 33-kHz
  2. 18-kHz
  3. 38-kHz
  4. 36 kHz

- 2-25. What magnetic tape recorder specification expresses the variation of the phase shift with respect to frequency?
1. Frequency response
  2. Phase response
  3. Wow and Flutter
  4. Each of the above
- 2-26. Which of the following conditions indicates that a magnetic tape recorder has a good phase response specification?
1. The SNR and frequency response are within tolerance
  2. The wave analyzer shows a perfect sine wave
  3. The recorder reproduces an undistorted square wave
  4. Each of the above
- 2-27. What magnetic tape recorder specification expresses the result of non-uniform tape motion caused by variations in tape speed that produces frequency modulation of signals recorded onto magnetic tape?
1. Frequency response
  2. Phase response
  3. Flutter
  4. Time-base error
- 2-28. Which of the following magnetic tape recorder transport parts can cause high frequency flutter (above 1000 Hz)?
1. Magnetic heads
  2. Rotating tape guides
  3. Fixed tape guides
  4. Both 1 and 3 above
- 2-29. A magnetic tape recorder's flutter specification is usually expressed as a percent of peak or as a peak-to-peak value for what type of recorder?
1. Audio
  2. Instrumentation
  3. Video
  4. All of the above
- 2-30. The time-base error (TBE) magnetic tape recorder specification is closely related to flutter. Which of the following statements best reflects this relationship?
1. TBE is an inverse measure of the effects of flutter on the stability of recorded data
  2. TBE is a direct measure of the effects of flutter on the frequency response of recorded data
  3. TBE is a direct measure of the effects of flutter on the stability of recorded data.
  4. TBE is a direct measure of the effects of flutter on the bias level of recorded data.
- 2-31. The simplest way to measure a recorder's TBE is with what test equipment?
1. VTVM
  2. Sweep analyzer
  3. Oscilloscope
  4. Ohmmeter
- 2-32. There are two types of skew. What type does not show up when magnetic tapes are recorded and reproduced on the same magnetic tape recorder?
1. Positive
  2. Dynamic
  3. Negative
  4. Fixed
- 2-33. Which of the following is NOT a cause of dynamic skew?
1. Gap scatter in the magnetic head stack
  2. Sticking tape transport guides
  3. Warped magnetic tape
  4. Worn tape transport guides



2-34. Which of the following is NOT a format for digital magnetic tape recording?

1. Serial-parallel
2. Bi-phase
3. Serial
4. Parallel

2-35. Which of the following digital magnetic tape recording formats is normally used for instrumentation recording when the input data rate is high?

1. Serial-Parallel
2. Serial
3. Both 1 and 2 above
4. Bi-phase

2-36. The return-to-bias digital magnetic tape recording encoding method uses magnetic tape that is normally in a "neutral" condition.

1. True
2. False

2-37. Which of the following digital magnetic tape encoding methods is the most widely used?

1. RB
2. NRZ
3. E-RZ
4. RZ

2-38. Which of the four variations of NRZ encoding works best in high density magnetic tape recording and offers a bit-error rate of one error per 1 million bits?

1. E-NRZ-L
2. NRZ-L
3. NRZ-M
4. NRZ-S

2-39. Digital magnetic tape recorders are used to store and retrieve which of the following types of data?

1. Computer programs
2. Radar and other pulsed type signals
3. Special signals with a bandwidth of less than 500 kHz
4. Each of the above

2-40. Telemetry digital magnetic tape recorders are frequently called wideband recorders.

1. True
2. False

2-41. Floppy disks are made of round plastic disks coated with magnetic oxide particles and enclosed in a plastic jacket.

1. True
2. False

2-42. When discussing floppy disks, what is meant by the "density" of a floppy disk?

1. The thickness of the plastic disk
2. How much the disk can store
3. The thickness of floppy disk jacket
4. The number of sectors on the disk

---

IN ANSWERING QUESTIONS 2-43 THROUGH 2-46, SELECT THE STORAGE CAPACITY IN COLUMN B THAT BEST DESCRIBES THE TYPE OF FLOPPY DISK IN COLUMN A.

- |                             |                    |
|-----------------------------|--------------------|
| 2-43. 5-1/4" double density | 1. 1,200,000 bytes |
|                             | 2. 720,000 bytes   |
| 2-44. 5-1/4" high density   | 3. 360,000 bytes   |
| 2-45. 3-1/2" double density | 4. 1,400,000 bytes |
| 2-46. 3-1/2" high density   |                    |
-

- 2-47. Data is stored on floppy disks in circular "tracks." Each track is then broken up into arcs called "cylinders."
1. True
  2. False
- 2-48. When a floppy disk is sectored using the soft sectoring method, the computer software determines the sector size and placement. What is this process called?
1. Centering
  2. Addressing
  3. Formatting
  4. Rastering
- 2-49. When you handle, store, or ship floppy disks, which of the following statements is NOT a precaution you should take?
1. Always store 8" and 5 1/4" floppy disks in their envelopes when not in use
  2. Always write on a floppy disk label first, and then place it on the disk
  3. Always lay floppy disks on their side when storing them
  4. Always ship floppy disks in their appropriate shipping containers
- 2-50. Which of the following items can generate magnetic fields that can destroy data on a floppy disk?
1. Paper clip
  2. Telephone
  3. Printer
  4. Both 2 and 3 above
- 2-51. How can you erase a floppy disk?
1. Record over it
  2. Degauss it
  3. Reformat it
  4. Both 2 and 3 above
- 2-52. A computer places data on a hard disk by using one of what two methods?
1. Cylinder or sector
  2. Cylinder or circular
  3. Sector or quadrant
  4. Sector or record
- 2-53. Using the sector method, a hard disk drive locates a place on a hard disk with only one platter by using three location numbers. Which of the following is NOT one of those location numbers?
1. Surface number
  2. Track number
  3. Cylinder number
  4. Sector number
- 2-54. When you handle, store, or ship removable hard disks, which of the following statements is NOT a precaution you should take?
1. Don't touch any exposed recording surfaces
  2. Keep them away from food, liquids, and cigarette smoke
  3. Store them in an environment that stays between 32 to 95 degrees Fahrenheit and 40 to 85% relative humidity
  4. Keep dirt, dust, etc., off of the recording surface by storing them in their case when not in use
- 2-55. How can you declassify a removable hard disk which contains classified information?
1. Reformat it
  2. Degauss it
  3. Both 1 and 2 above
  4. Destroy it using the procedures in OPNAVINST 5510.1

- 2-56. Which of the following encoding methods is NOT used for encoding digital data onto magnetic disks?
1. Sector encoding
  2. Run length limited
  3. Modified frequency modulation
  4. Frequency modulation

- 2-63. Why do floppy disk drives require more preventive maintenance than hard disk drives?
1. They are not sealed units
  2. Oxide coating from disks sticks to transport parts
  3. Both 1 and 2 above
  4. The drive circuit board is less protected

---

IN ANSWERING QUESTIONS 2-57 THROUGH 2-60, SELECT THE DESCRIPTION IN COLUMN B THAT DESCRIBES THE FLOPPY DISK DRIVE PART LISTED IN COLUMN A.

- |                                       |  |
|---------------------------------------|--|
| 2-57. Head arm assembly               | 1. Holds and spins the floppy disk                   |
| 2-58. Drive electronics circuit board | 2. Holds the magnetic read/write heads               |
| 2-59. Drive motor/spindle assembly    | 3. Controls the electromechanical-high density parts |
| 2-60. Actuator arm assembly           | 4. Positions the heads over the disks                |

- 2-64. Which of the following is a main function of the control electronics part of a disk drive's electronics component?
1. Take incoming data from the interface electronics
  2. Spin the disk at the proper speed
  3. Move the heads across the recording surface
  4. Both 2 and 3 above

- 2-65. Which of the following is a function of the interface electronics part of a disk drive's electronics component?
1. Convert data from the host computer from serial to parallel, and vice versa, as needed
  2. Receive write/read control signals from the host computer
  3. Receive control signals to format a disk from the host computer
  4. All of the above

- 
- 2-61. What part of a hard disk drive transport uses either a dc stepper motor or a voice coil to position the heads for writing data to the correct track of the disk pack?
1. Drive motor/spindle assembly
  2. Head arm assembly
  3. Actuator arm assembly
  4. Drive electronics circuit board

- 2-66. Which of the following is NOT one of the five most common disk drive interfaces in use today?

- 2-62. What part of a hard disk drive transport holds the four magnetic heads, and is attached to the transport's actuator arm assembly?
1. Cylinder assembly
  2. Head arm assembly
  3. Sectoring assembly
  4. Drive motor/spindle assembly

1. Drive motor/spindle interface
2. Naval tactical data system interface
3. ST-506/412 interface
4. Enhanced small device interface

2-67. What type of disk drive interface is often used in the hard disk drives installed in older IBM-compatible desktop computers that have a maximum capacity of 125MB?

1. Drive motor/spindle interface
2. Enhanced small device interface
3. ST-506/412 interface
4. Integrated drive electronics

2-68. What type of disk drive interface uses a high-level interface which requires only a logical sector number to locate the desired data on a disk?

1. Enhanced small device interface
2. Integrated drive electronics
3. Drive motor/spindle interface
4. Small computer systems interface

2-69. What type of disk drive interface includes all of the controller card electronics in the hard disk drive and offers a transfer rate of up to 1 MB?

1. Small computer systems interface
2. Integrated drive electronics
3. Naval tactical data system
4. Enhanced small device interface

2-70. Which of the following is NOT a benefit of the SCSI disk drive interface over previous interfaces?

1. Can handle disk drives of almost any size
2. Disconnects itself from the host computer's bus while it processes requests
3. Can transfer data up to 24 Mbits/sec
4. Can daisy-chain up to eight units off of one controller

---

IN ANSWERING QUESTIONS 2-71 THROUGH 2-74, SELECT THE MAGNETIC DISK RECORDING SPECIFICATION IN COLUMN B THAT MATCHES THE DEFINITION IN COLUMN A.

- |  |                      |
|--|----------------------|
| 2-71. Indicates number of physical sectors that are between logical sectors on a hard disk           | 1. Seek time         |
| 2-72. Total time it takes a disk drive to retrieve a sector of data                                  | 2. Latency period    |
| 2-73. Time it takes for a magnetic head to position itself over a specific track                     | 3. Access time       |
| 2-74. Time it takes a specific sector of a specific track to position itself under the magnetic head | 4. Interleave factor |

---

2-75. The speed at which a disk drive and a disk drive controller working together can transfer data to the host computer is what disk recording specification?

1. Seek time
2. Transfer rate
3. Access time
4. Interleave factor